

Karty ratownicze

FordService

Feel the difference



Karty ratownicze

Ford

Uwaga prawna

Karty ratownicze zostały opracowane jako materiał pomocniczy dla specjalnie przeszkolonego personelu służb ratowniczych, niosącego pomoc w razie wypadków drogowych z udziałem pojazdów Ford sprzedawanych na obszarze Unii Europejskiej.

Informacje zawarte w tej publikacji były poprawne w chwili oddawania do druku.

Zgodnie z naszą dewizą zakładającą stały rozwój i doskonalenie naszych produktów, zastrzegamy sobie prawo do dokonywania, w dowolnym momencie i bez uprzedzenia, wszelkich niezbędnych zmian w zakresie specyfikacji, konstrukcji lub wyposażenia.

Żadna część niniejszej publikacji nie może być odtwarzana ani przechowywana w systemach przechowywania danych lub przekazywana w jakiegokolwiek formie ani też tłumaczona na jakikolwiek język, w jakiegokolwiek postaci i w jakikolwiek sposób bez naszej pisemnej zgody.

Nie ponosimy odpowiedzialności za ewentualne nieścisłości i przeoczenia.

Wszelkie prawa zastrzeżone.

(Data publikacji : 04/2014)

Karty ratownicze

Ford

Model	Data produkcji	Model	Data produkcji
B		• Focus - LPG (Wersja 3-drzwiowa)	07/2004 – 08/2007
• B-MAX	08/2012 – >	• Focus - CNG (Wersja 3-drzwiowa)	07/2004 – 08/2007
• B-MAX - LPG	03/2013 – >	• Focus - CNG (Wersja 3-drzwiowa)	08/2007 – 03/2011
C		• Focus (Wersja 4-drzwiowa)	07/2004 – 08/2007
• C-MAX	06/2003 – 10/2007	• Focus (Wersja 4-drzwiowa)	08/1998 – 12/2004
• C-MAX	10/2007 – 12/2010	• Focus (Wersja 4-drzwiowa)	08/2007 – 03/2011
• C-MAX	11/2010 – >	• Focus (Wersja 4-drzwiowa)	03/2011 – >
• C-MAX - LPG	06/2003 – 10/2007	• Focus (Wersja 5-drzwiowa)	08/2007 – 03/2011
• C-MAX - LPG	10/2007 – 12/2010	• Focus (Wersja 5-drzwiowa)	08/1998 – 12/2004
• C-MAX - CNG	06/2003 – 10/2007	• Focus (Wersja 5-drzwiowa)	03/2011 – >
• C-MAX - CNG	10/2007 – 12/2010	• Focus (Wersja 5-drzwiowa)	07/2004 – 08/2007
• C-MAX (MAV w wersji Grand (5+2-osobowy))	11/2010 – >	• Focus - LPG (Wersja 5-drzwiowa)	08/2007 – 03/2011
• C-MAX - LPG (MAV w wersji kompaktowej (5-osobowy))	06/2012 – >	• Focus - LPG (Wersja 5-drzwiowa)	07/2004 – 08/2007
E		• Focus - LPG (Wersja 5-drzwiowa)	05/2012 – >
• Eco Sport	09/2013 – >	• Focus - CNG (Wersja 5-drzwiowa)	08/2007 – 03/2011
F		• Focus - CNG (Wersja 5-drzwiowa)	07/2004 – 08/2007
• Fiesta	01/1996 – 02/2000	• Focus E=LECTRIC	
• Fiesta	02/2000 – 02/2002	• Fusion	06/2002 – >
• Fiesta (Wersja 3-drzwiowa)	06/2008 – >	G	
• Fiesta (Wersja 3-drzwiowa)	11/2001 – 09/2008	• Galaxy	02/2006 – >
• Fiesta - LPG (Wersja 3-drzwiowa)	06/2008 – >	• Galaxy	04/2000 – 02/2006
• Fiesta (Wersja 5-drzwiowa)	11/2001 – 09/2008	K	
• Fiesta (Wersja 5-drzwiowa)	06/2008 – >	• KA	08/2008 – >
• Fiesta - LPG (Wersja 5-drzwiowa)	06/2008 – >	• KA	09/1996 – 07/2008
• Focus (Kombi)	07/2004 – 08/2007	• Kuga	02/2008 – 10/2012
• Focus (Kombi)	08/2007 – 03/2011	• Kuga	10/2012 – >
• Focus (Kombi)	08/1998 – 12/2004	M	
• Focus (Kombi)	03/2011 – >	• Mondeo (Kombi)	10/2000 – 02/2007
• Focus - LPG (Kombi)	08/2007 – 03/2011	• Mondeo (Kombi)	02/2007 – >
• Focus - LPG (Kombi)	07/2004 – 08/2007	• Mondeo - LPG (Kombi)	02/2007 – >
• Focus - LPG (Kombi)	05/2012 – >	• Mondeo (Wersja 4-drzwiowa)	10/2000 – 02/2007
• Focus (Sktadany)	03/2007 – 07/2010	• Mondeo (Wersja 4-drzwiowa)	02/2007 – >
• Focus (Wersja 3-drzwiowa)	07/2004 – 08/2007	• Mondeo - LPG (Wersja 4-drzwiowa)	02/2007 – >
• Focus (Wersja 3-drzwiowa)	08/2007 – 03/2011	• Mondeo (Wersja 5-drzwiowa)	10/2000 – 02/2007
• Focus (Wersja 3-drzwiowa)	08/1998 – 12/2004		
• Focus - LPG (Wersja 3-drzwiowa)	08/2007 – 03/2011		

Karty ratownicze

Ford

Model	Data produkcji	Model	Data produkcji
• Mondeo (Wersja 5-drzwiowa)	02/2007 – >		
• Mondeo - LPG (Wersja 5-drzwiowa)	02/2007 – >		
R			
• Ranger	06/2006 – 07/2011		
• Ranger	07/2011 – >		
S			
• S-MAX	02/2006 – >		
• Streetka (Sktadany)	01/2003 – 07/2005		
T			
• Tourneo Connect	09/2013 – >		
• Tourneo Connect	06/2002 – 07/2013		
• Tourneo Courier	03/2014 – >		
• Tourneo Custom	07/2012 – >		
• Transit Tourneo	08/2007 – >		

Ford B-MAX



E157559

08/2012 – >

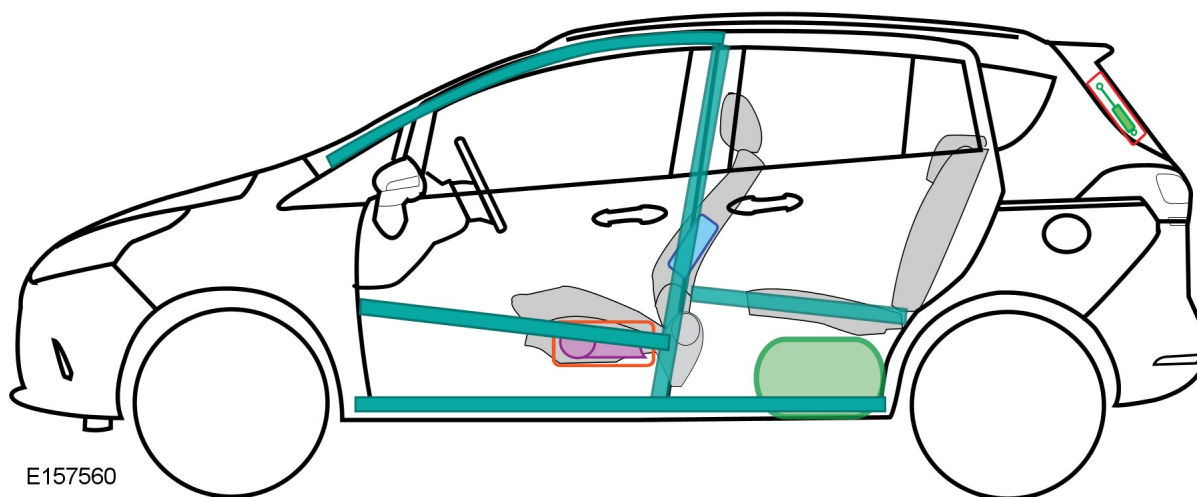
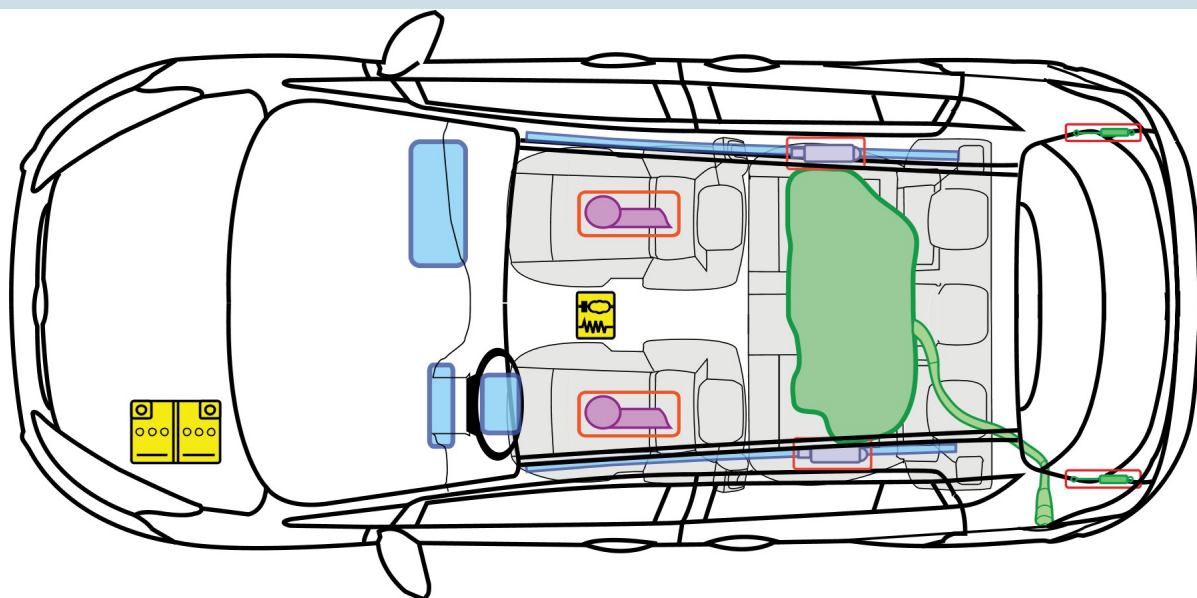

E157560

Legenda

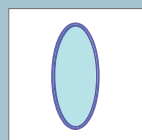

Ochronna poduszka powietrzna

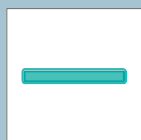

Wzmocnienia konstrukcji



Sterownik

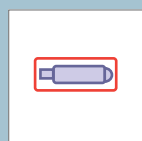

Generator gazu

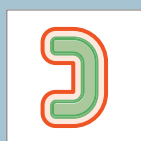

Aktywna ochrona w przypadku wywrócenia pojazdu
Sprężyna gazowa

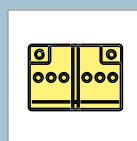

Akumulator

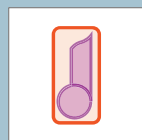

Napinacze pasów

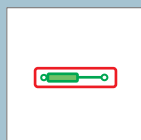

Zbiornik paliwa

B

Ford B-MAX - LPG



03/2013 – >

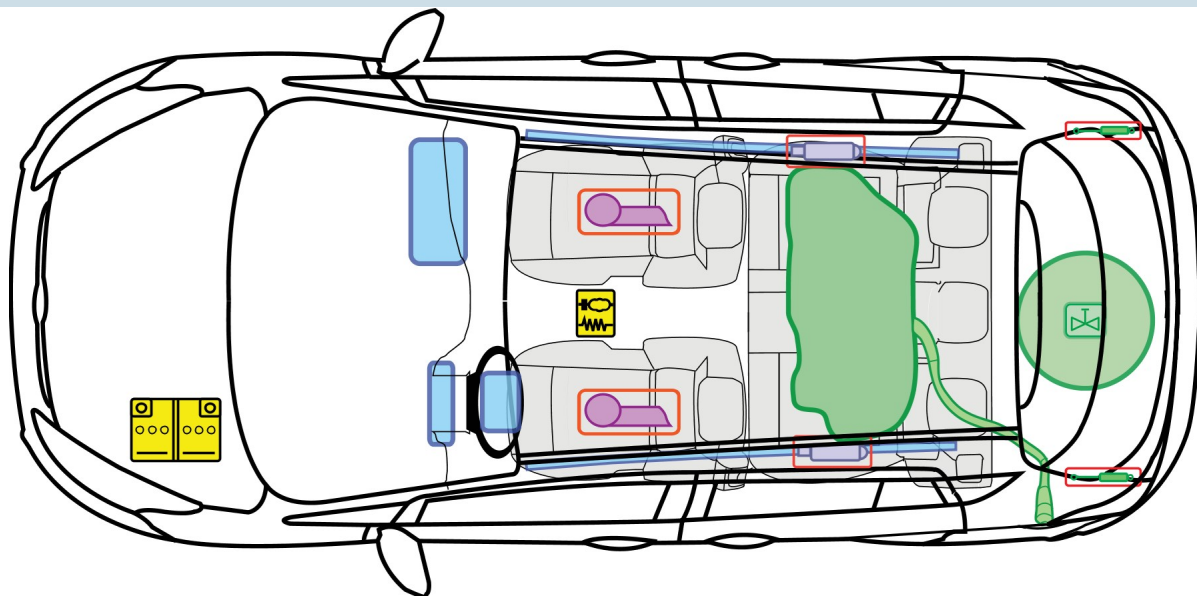

LPG

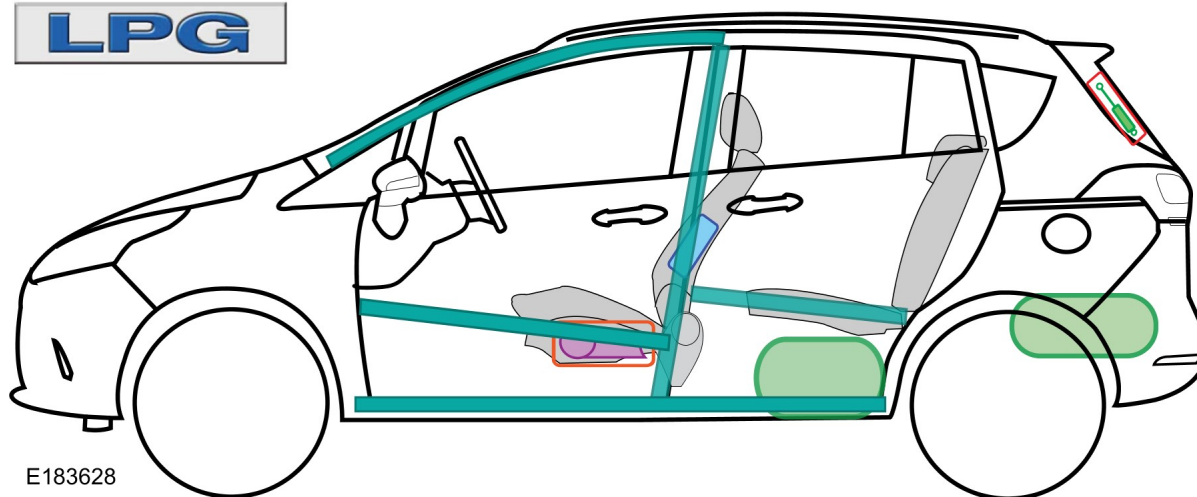

E183628

Legenda

B

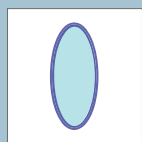

Ochronna poduszka powietrzna

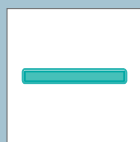

Wzmocnienia konstrukcji



Sterownik

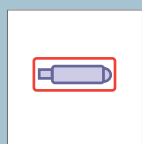

Generator gazu



Aktywna ochrona w przypadku wywrócenia pojazdu
Sprężyna gazowa

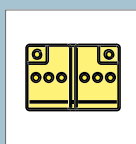

Akumulator



Zbiornika gazu

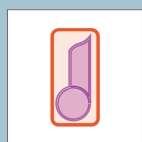

Napinaczy pasów

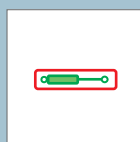

Zbiornik paliwa



Zawór bezpieczeństwa

Ford C-MAX

E135972



06/2003 – 10/2007

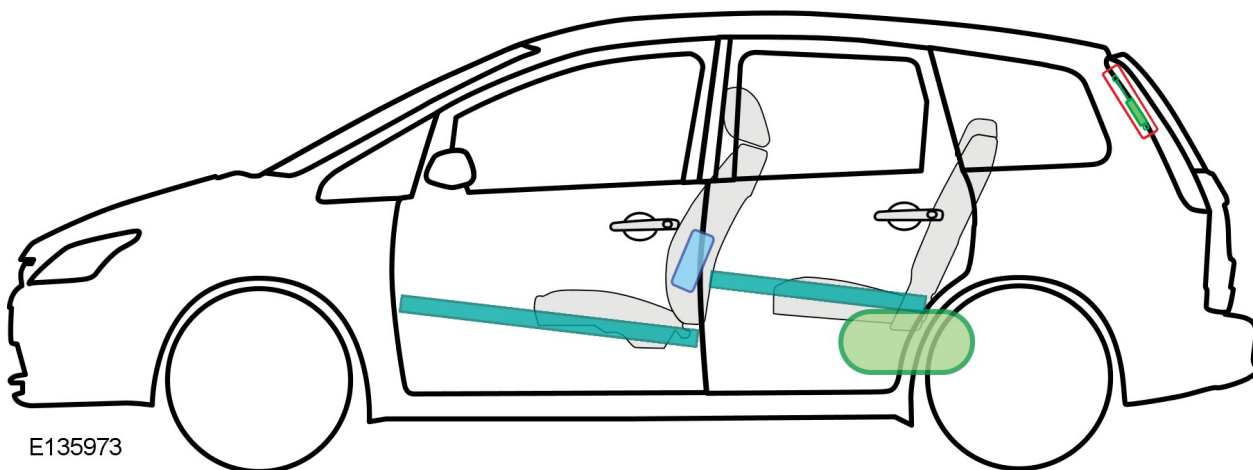
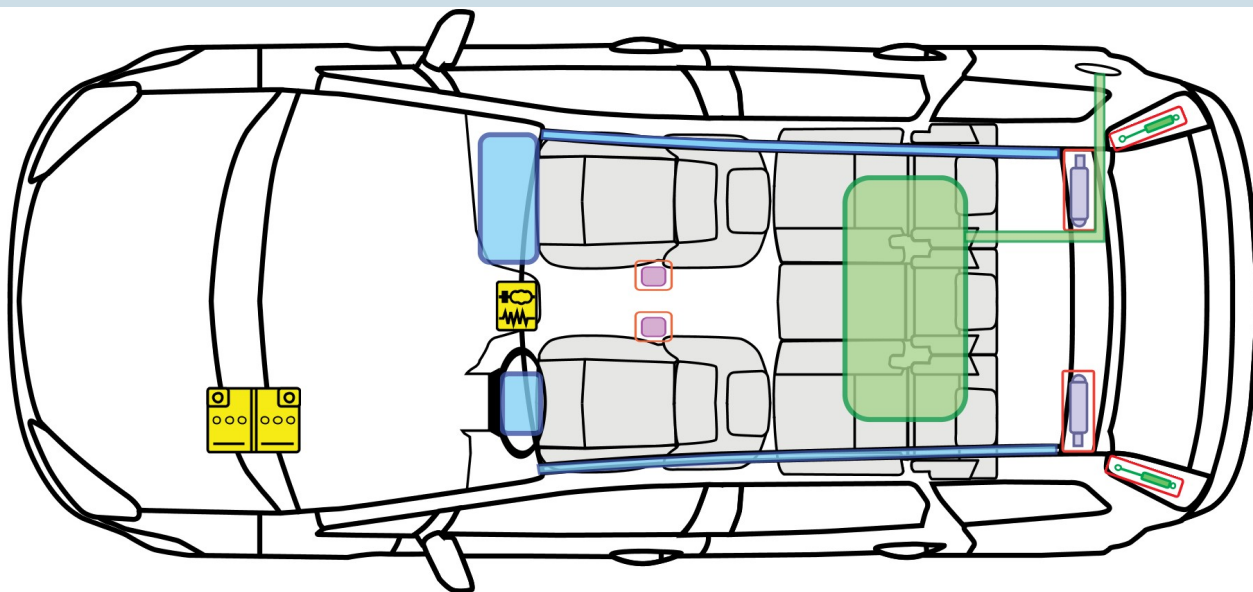

E135973

Legenda

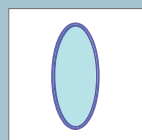

Ochronna poduszka powietrzna

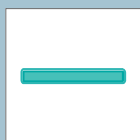

Wzmocnienia konstrukcji



Sterownik

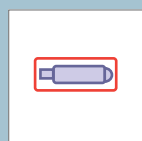

Generator gazu



Aktywna ochrona w przypadku wywrócenia pojazdu
Sprężyna gazowa

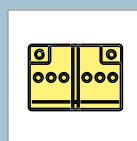

Akumulator

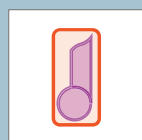

Napinacze pasów

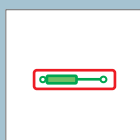

Zbiornik paliwa

Ford C-MAX

E135972



10/2007 – 12/2010

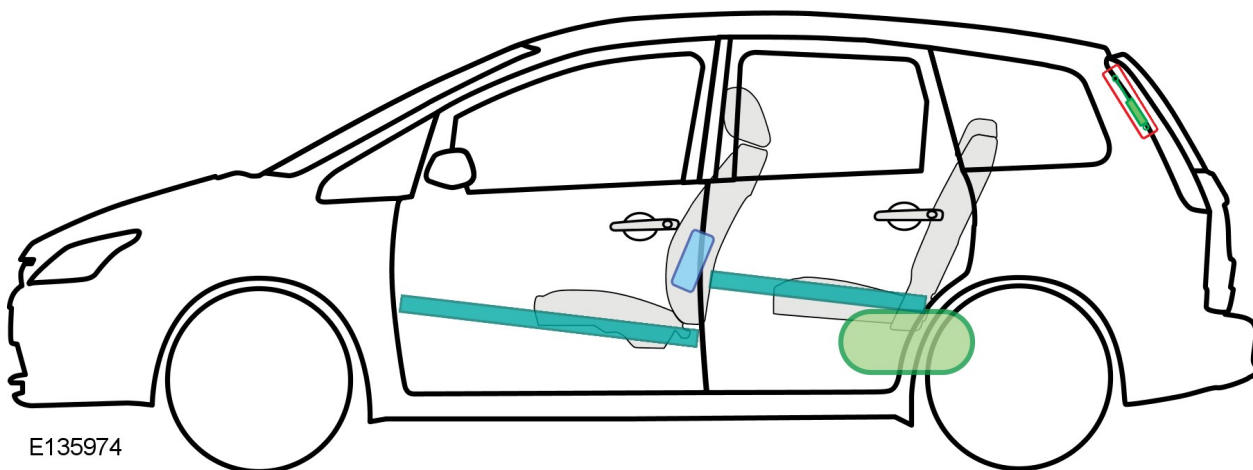
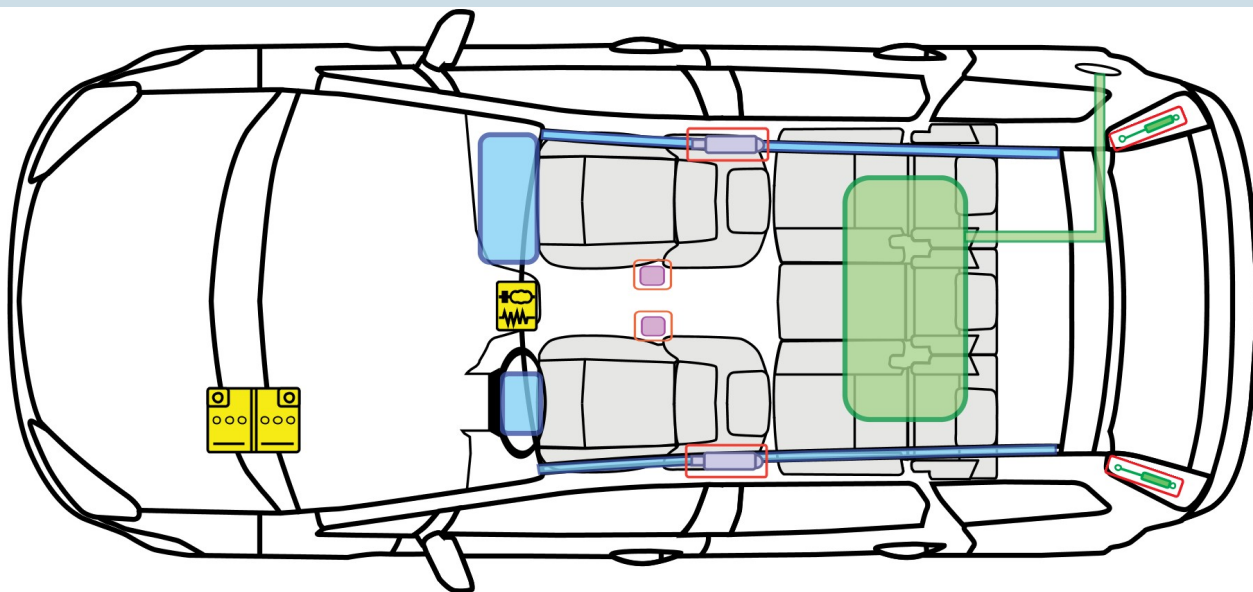

E135974

Legenda

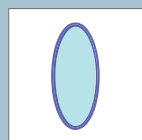

Ochronna poduszka powietrzna

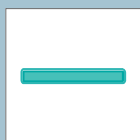

Wzmocnienia konstrukcji



Sterownik

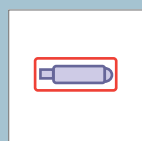

Generator gazu



Aktywna ochrona w przypadku wywrócenia pojazdu
Sprężyna gazowa

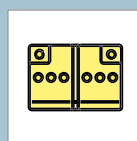

Akumulator

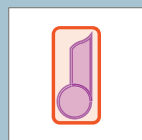

Napinacze pasów

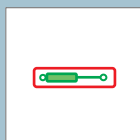

Zbiornik paliwa

FordC-MAX



11/2010 – >

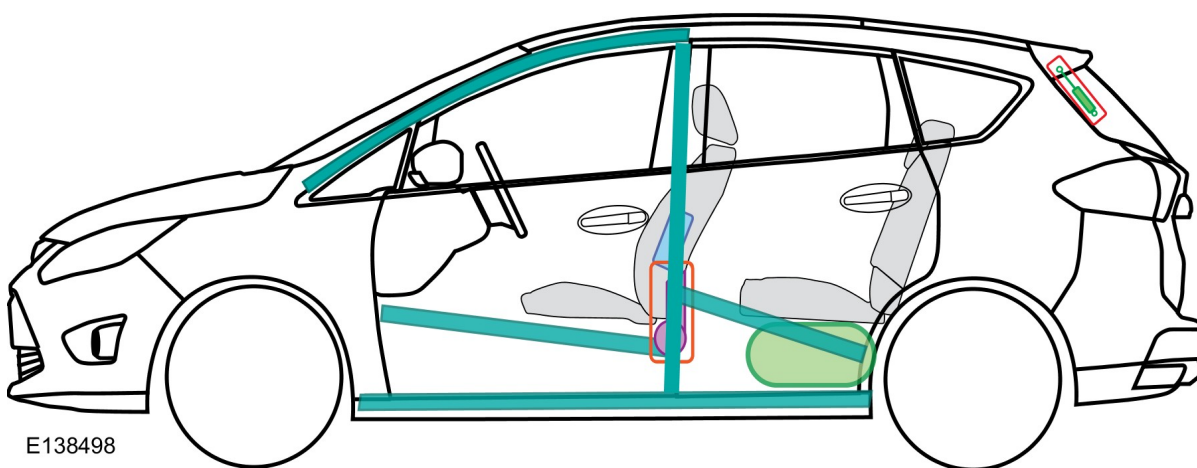
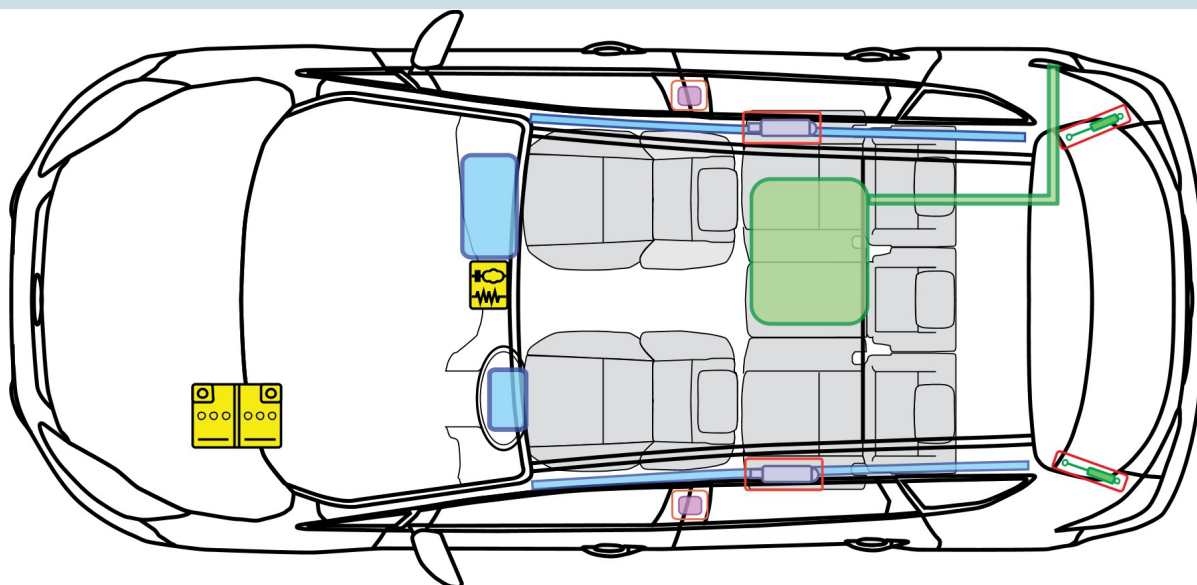

E138498

Legenda

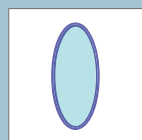

Ochronna poduszka powietrzna

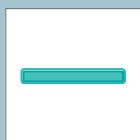

Wzmocnienia konstrukcji



Sterownik

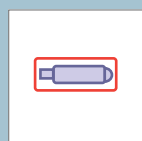

Generator gazu



Aktywna ochrona w przypadku wywrócenia pojazdu
Sprężyna gazowa

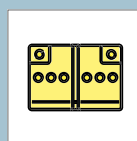

Akumulator

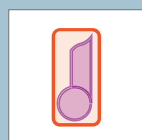

Napinaczy pasów

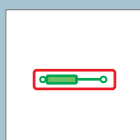

Zbiornik paliwa



Ford C-MAX - LPG



06/2003 – 10/2007

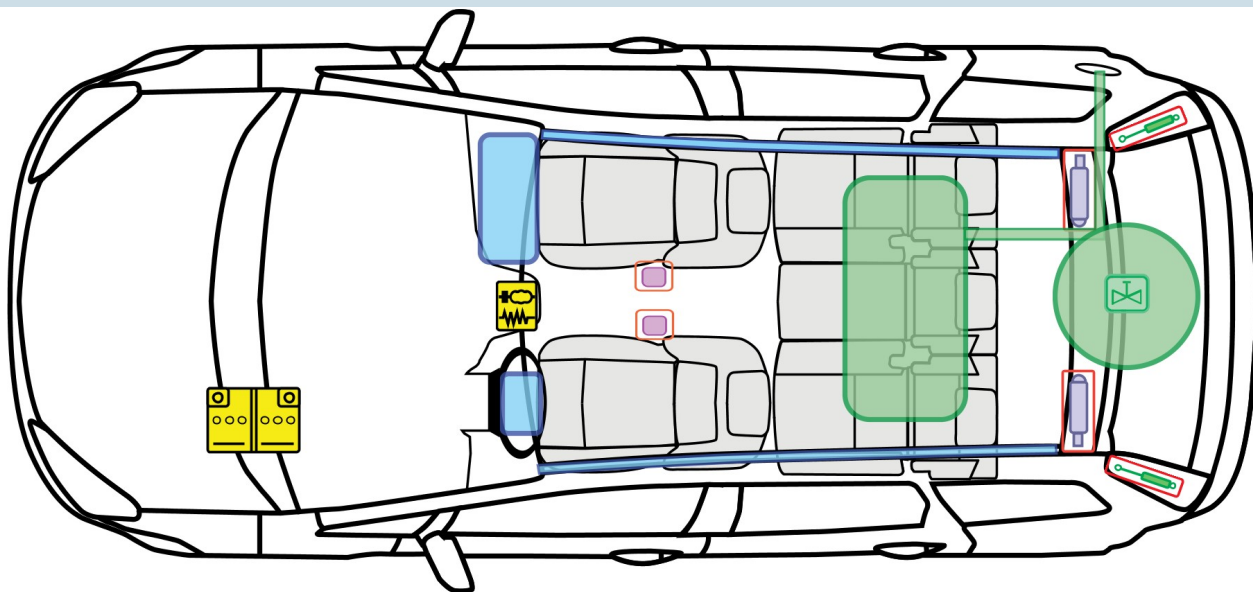

LPG

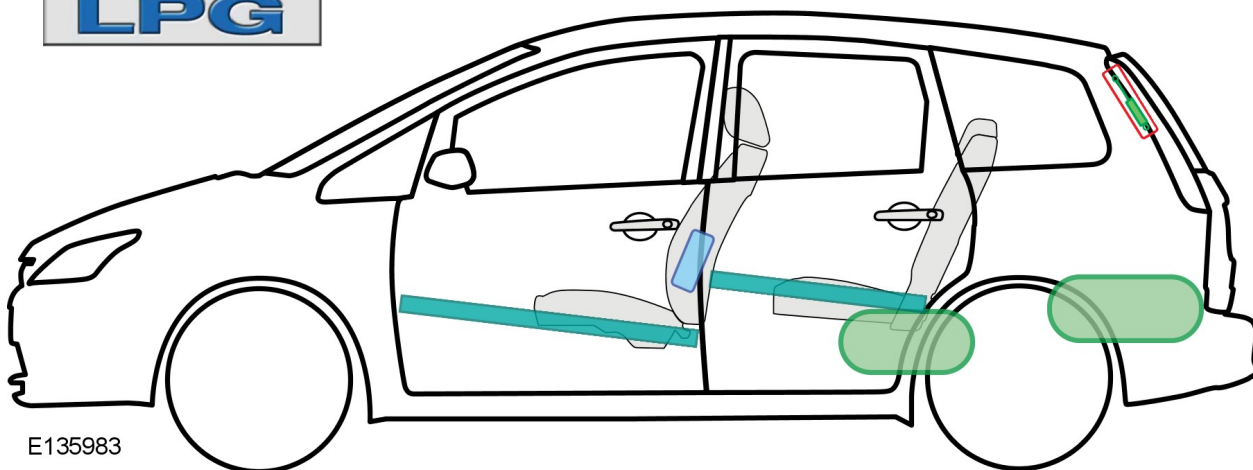

E135983

Legenda

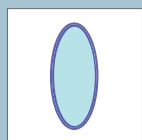

Ochronna poduszka powietrzna

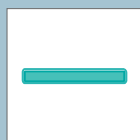

Wzmocnienia konstrukcji



Sterownik

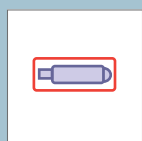

Generator gazu



Aktywna ochrona w przypadku wywrócenia pojazdu
Sprężyna gazowa

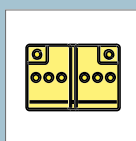

Akumulator



Zbiornika gazu

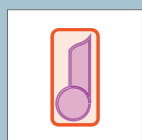

Napinaczy pasów

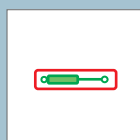

Zbiornik paliwa



Zawór bezpieczeństwa

Ford C-MAX - LPG



E135972

10/2007 – 12/2010

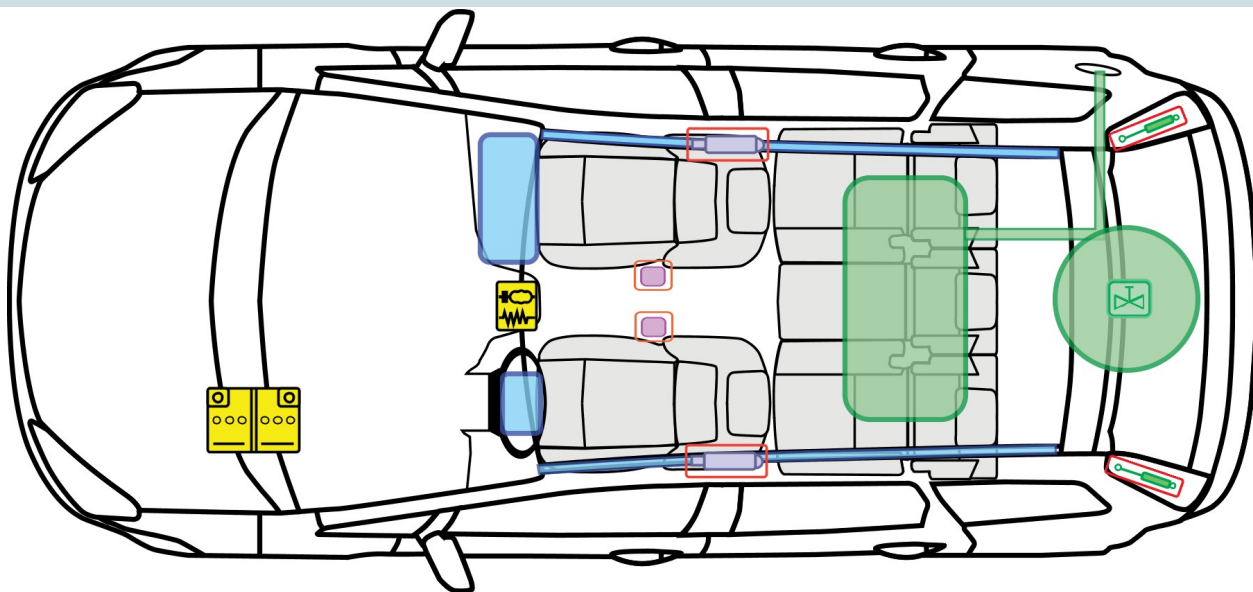

LPG

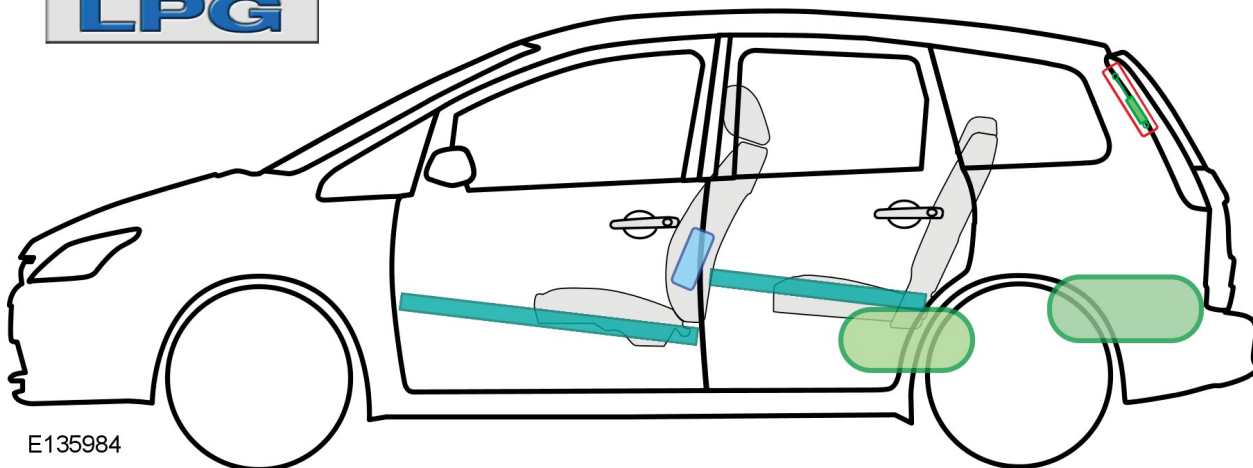

E135984

Legenda

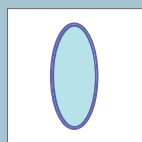

Ochronna poduszka powietrzna

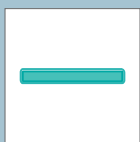

Wzmocnienia konstrukcji



Sterownik

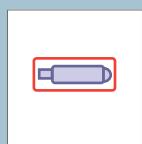

Generator gazu

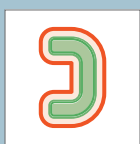

Aktywna ochrona w przypadku wywrócenia pojazdu
Sprężyna gazowa

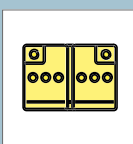

Akumulator



Zbiornika gazu

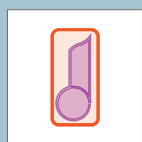

Napinaczy pasów



Sprężyna gazowa



Zbiornik paliwa



Zawór bezpieczeństwa

Ford C-MAX - CNG



E135972

06/2003 – 10/2007

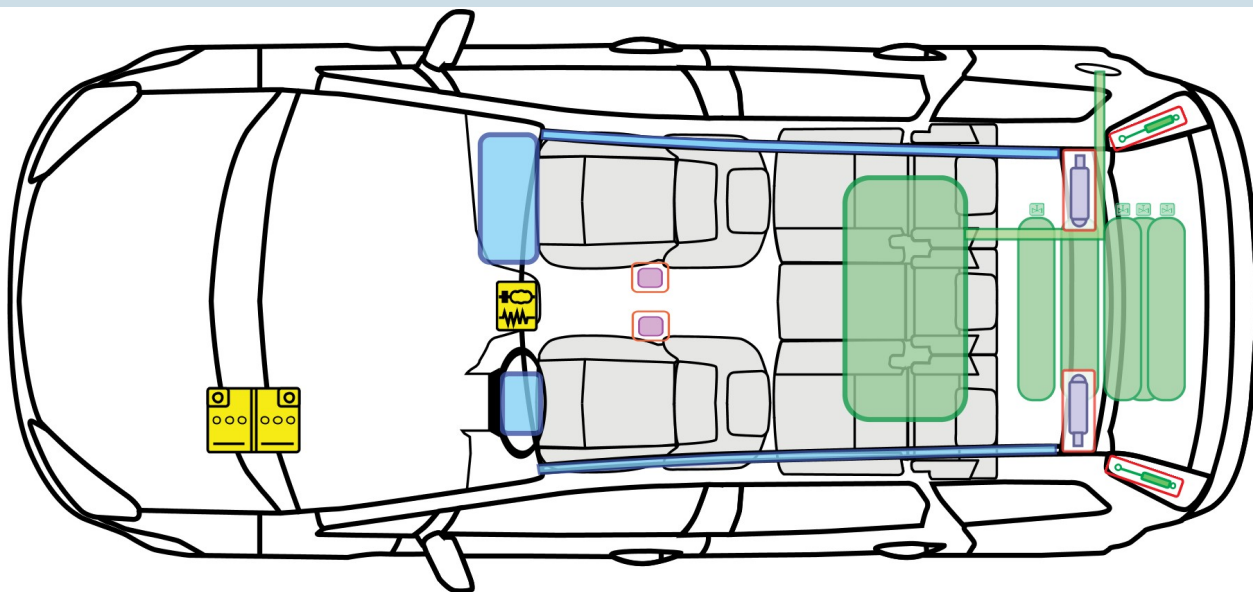

CNG

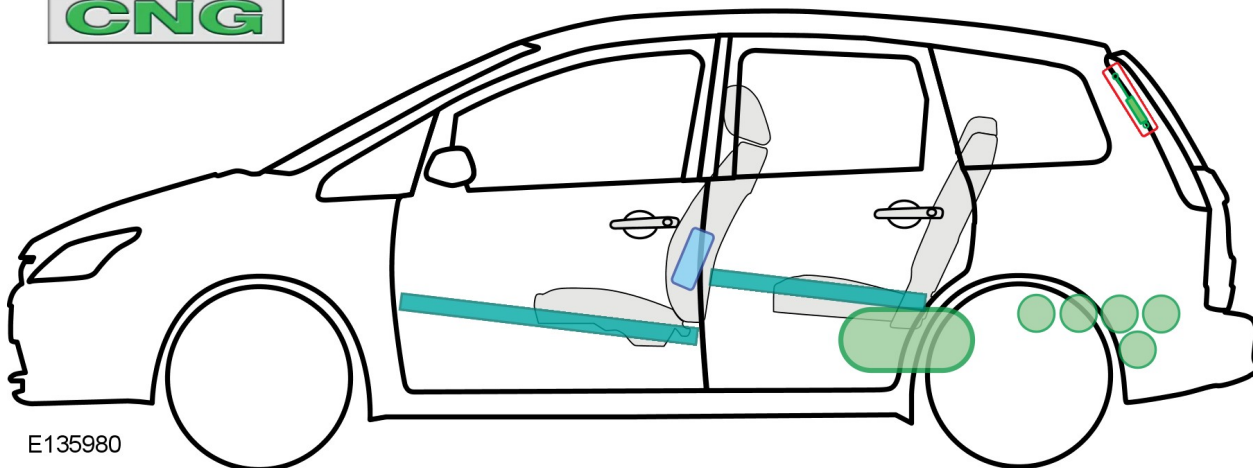

E135980

Legenda

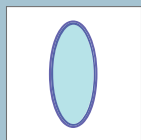

Ochronna poduszka powietrzna

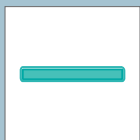

Wzmocnienia konstrukcji



Sterownik

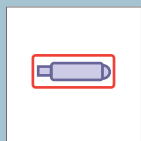

Generator gazu



Aktywna ochrona w przypadku wywrócenia pojazdu
Sprężyna gazowa

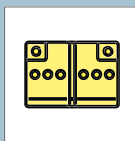

Akumulator



Zbiornika gazu

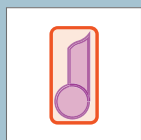

Napinacze pasów



Zawór bezpieczeństwa



Zbiornik paliwa



Zawór bezpieczeństwa

Ford C-MAX - CNG

E135972



10/2007 – 12/2010

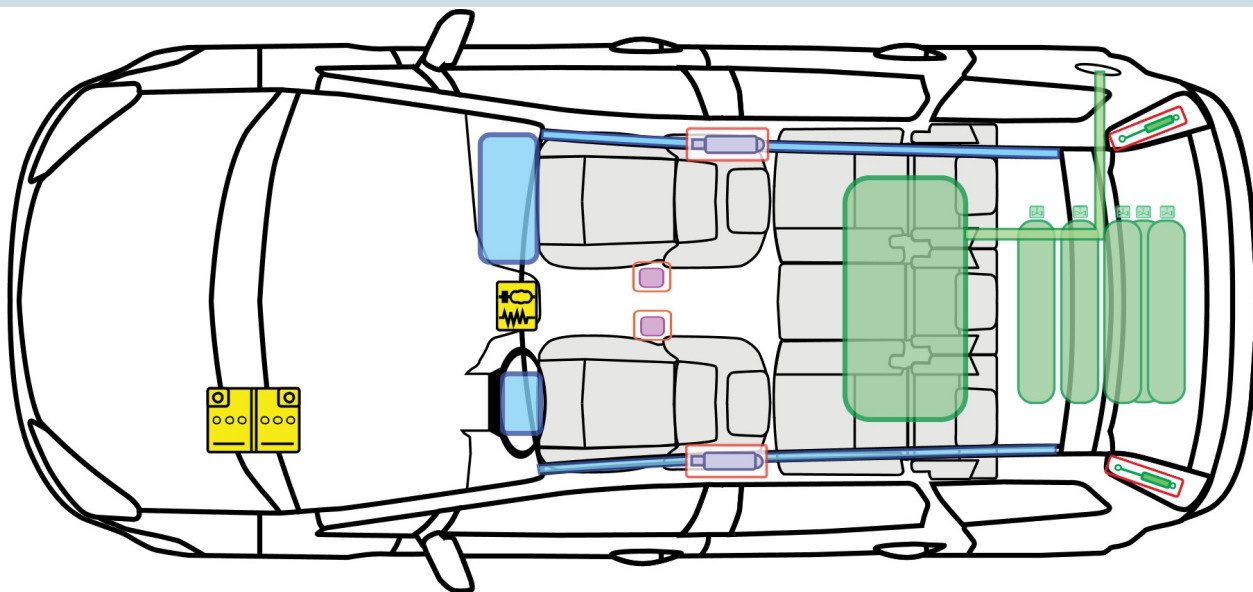

CNG

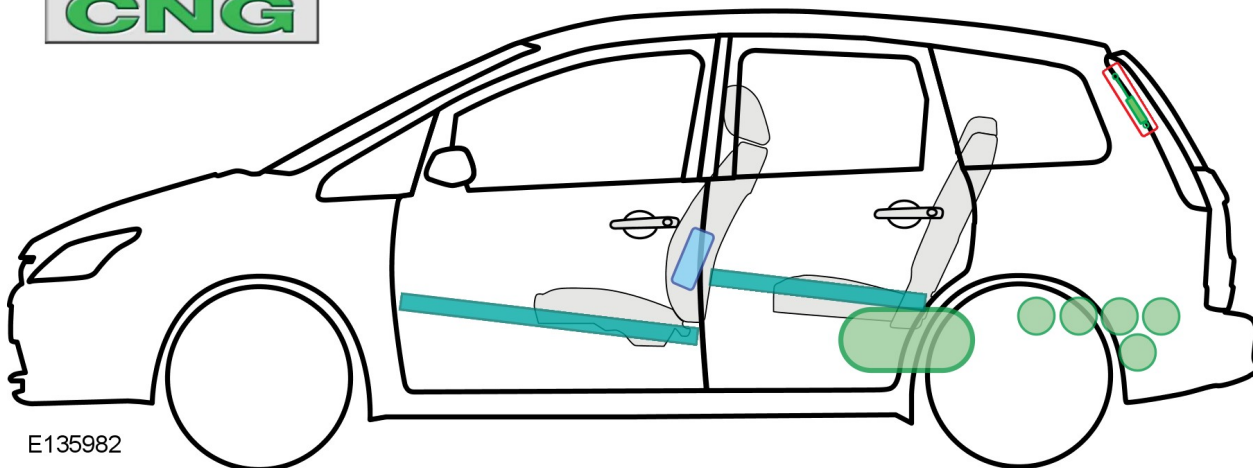

E135982

Legenda

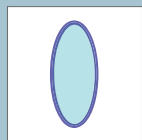

Ochronna poduszka powietrzna

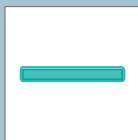

Wzmocnienia konstrukcji



Sterownik

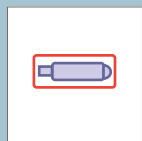

Generator gazu



Aktywna ochrona w przypadku wywrócenia pojazdu
Sprężyna gazowa

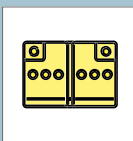

Akumulator



Zbiornika gazu

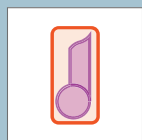

Napinaczy pasów

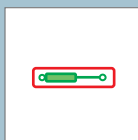

Zbiornik paliwa



Zawór bezpieczeństwa

Ford C-MAX MAV w wersji Grand (5+2-osobowy)



E138486

11/2010 – >

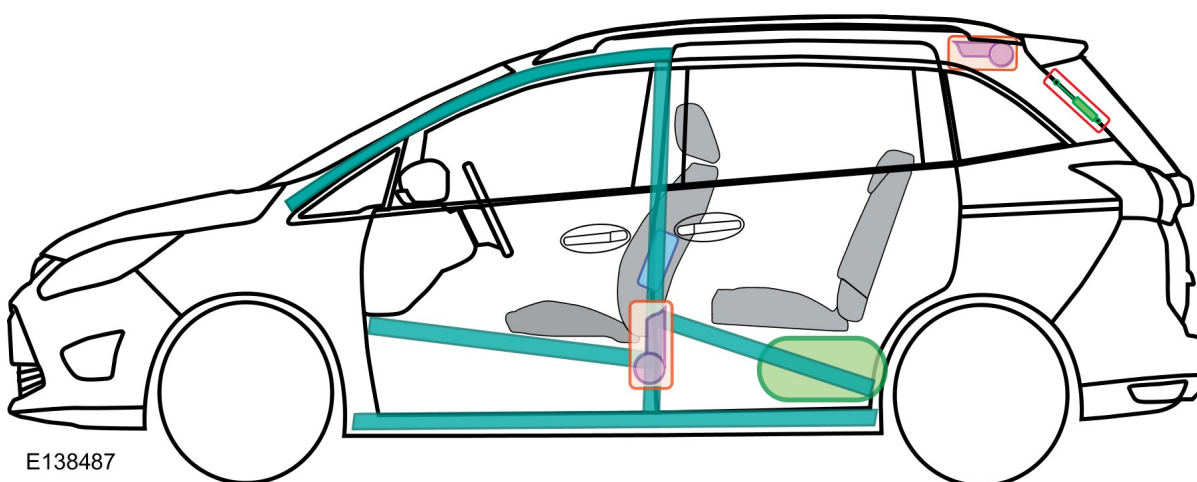
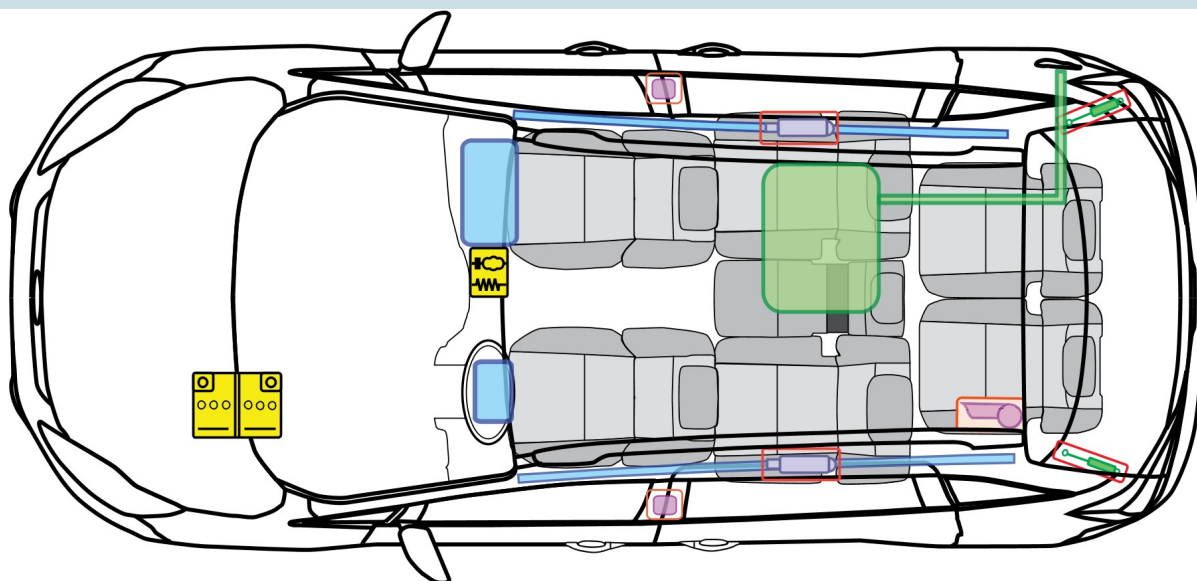

E138487

Legenda

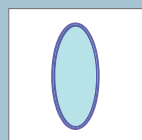

Ochronna poduszka powietrzna

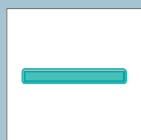

Wzmocnienia konstrukcji



Sterownik

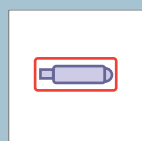

Generator gazu

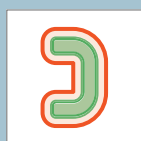

Aktywna ochrona w przypadku wywrócenia pojazdu
Sprężyna gazowa

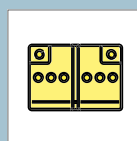

Akumulator

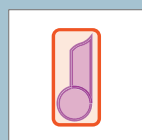

Napinacze pasów

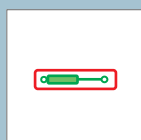

Zbiornik paliwa

Ford C-MAX - LPG MAV w wersji kompaktowej (5-osobowy)



E138486

06/2012 - >

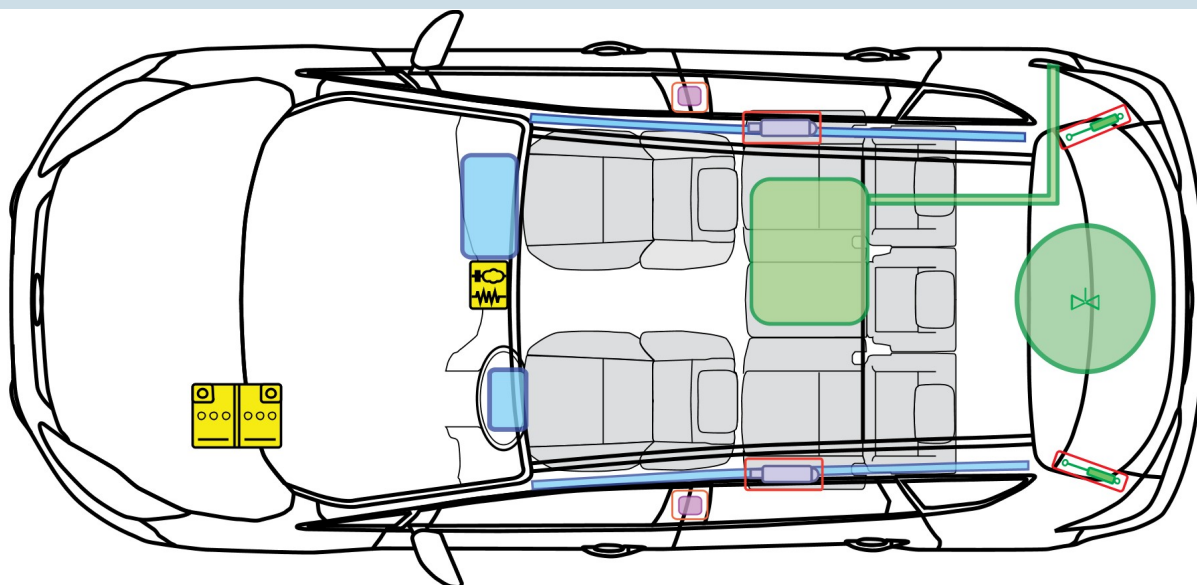

LPG

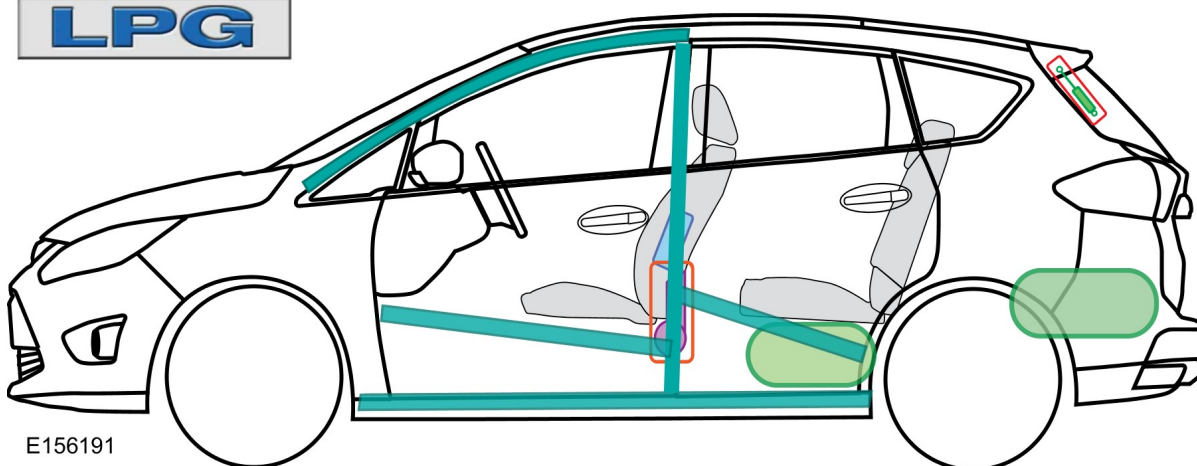

E156191

Legenda

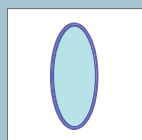

Ochronna poduszka powietrzna

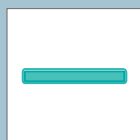

Wzmocnienia konstrukcji



Sterownik

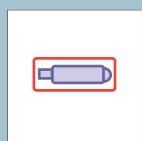

Generator gazu



Aktywna ochrona w przypadku wywrócenia pojazdu
Sprężyna gazowa

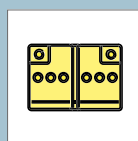

Akumulator



Zbiornika gazu

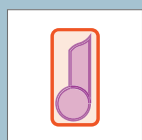

Napinacze pasów



Zbiornik paliwa



Zawór bezpieczeństwa

FordEco Sport



E178558

09/2013 – >

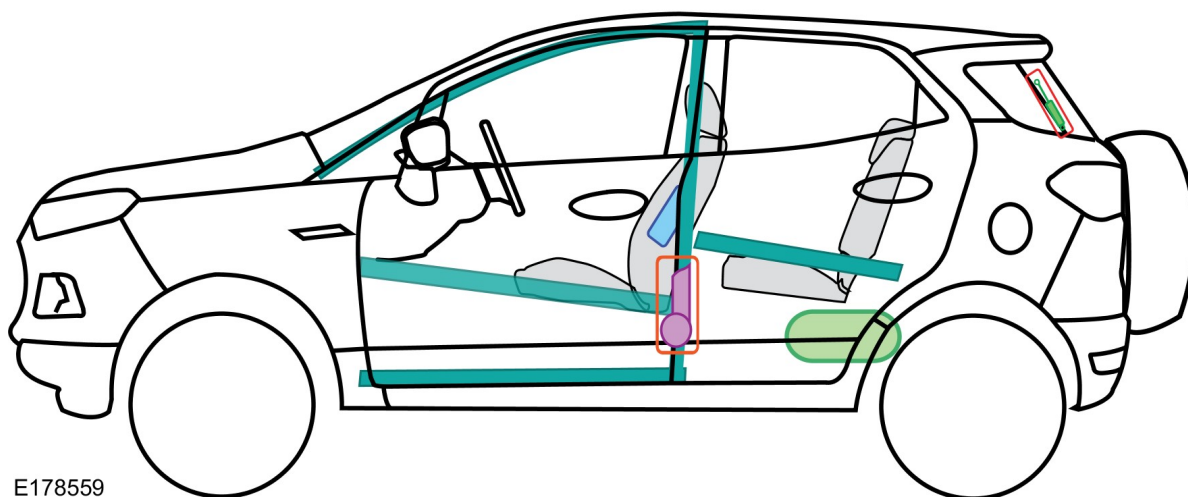
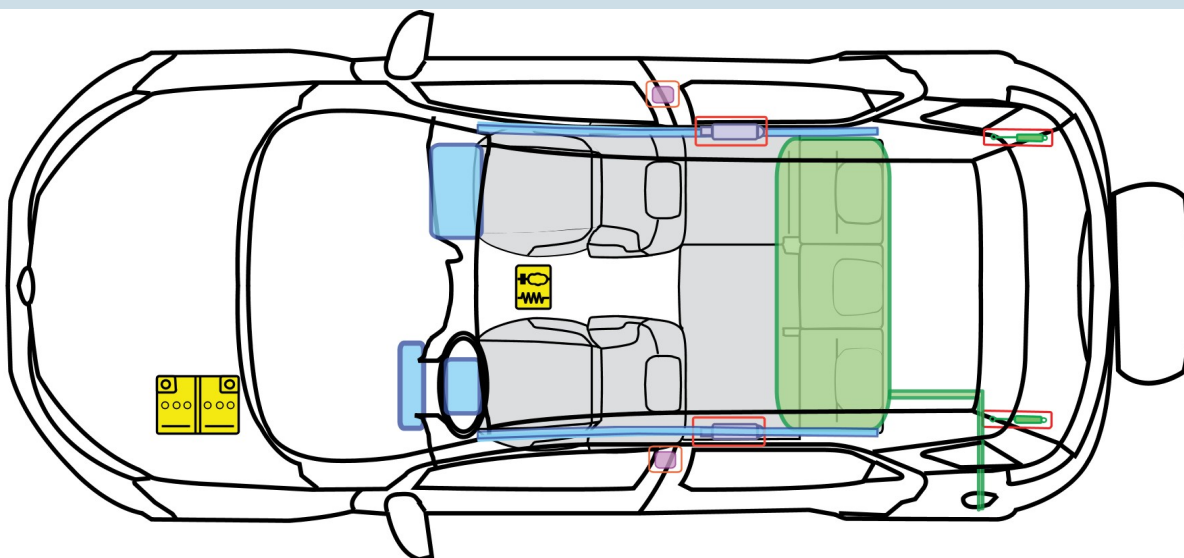

E178559

Legenda

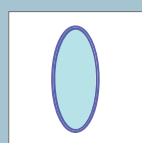

Ochronna poduszka powietrzna

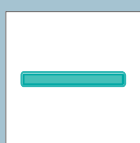

Wzmocnienia konstrukcji



Sterownik

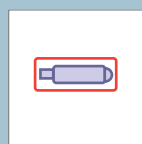

Generator gazu



Aktywna ochrona w przypadku wywrócenia pojazdu
Sprężyna gazowa

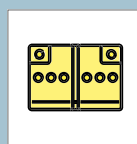

Akumulator

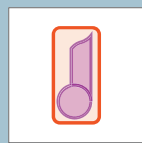

Napinacze pasów

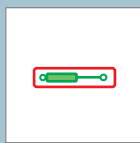

Zbiornik paliwa

Ford Fiesta



E137299

01/1996 – 02/2000

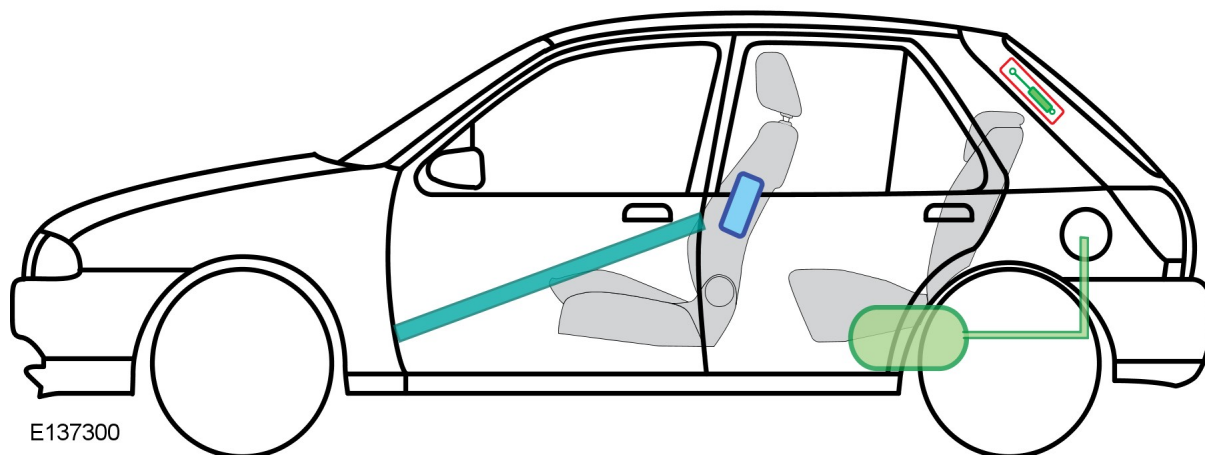
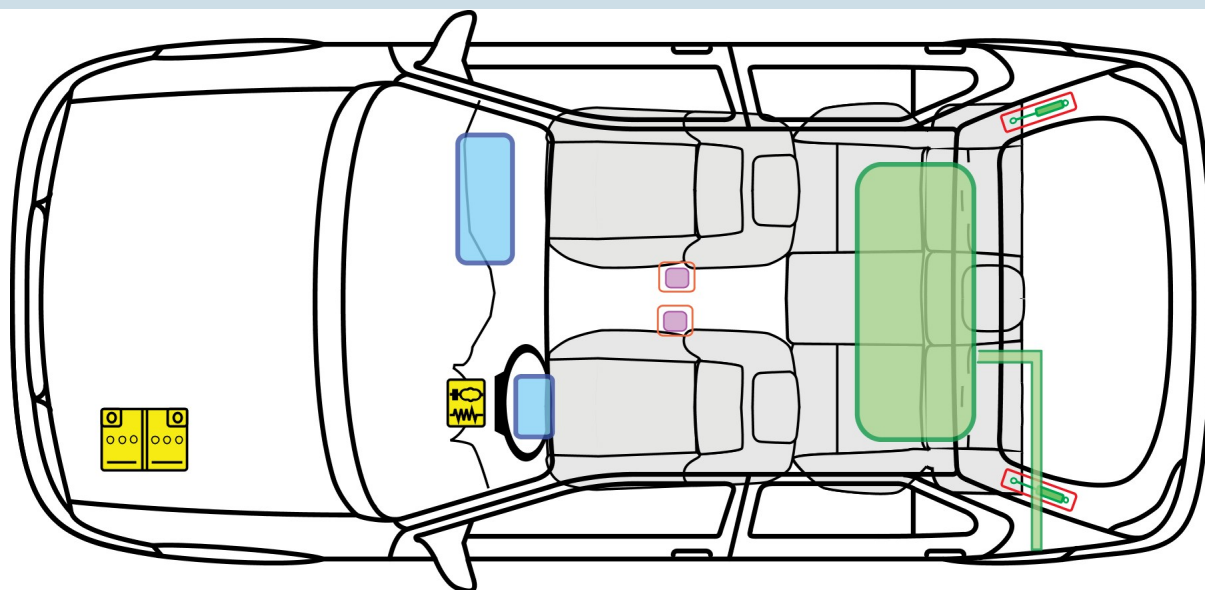

E137300

Legenda

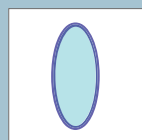

Ochronna poduszka powietrzna

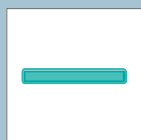

Wzmocnienia konstrukcji



Sterownik

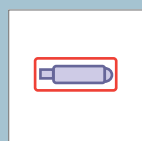

Generator gazu

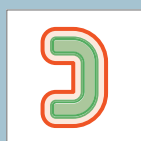

Aktywna ochrona w przypadku wywrócenia pojazdu

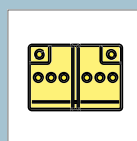

Akumulator

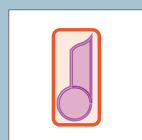

Napinacze pasów

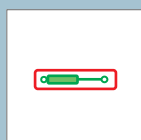

Sprężyna gazowa



Zbiornik paliwa

F



Ford Fiesta



E170168

02/2000 – 02/2002

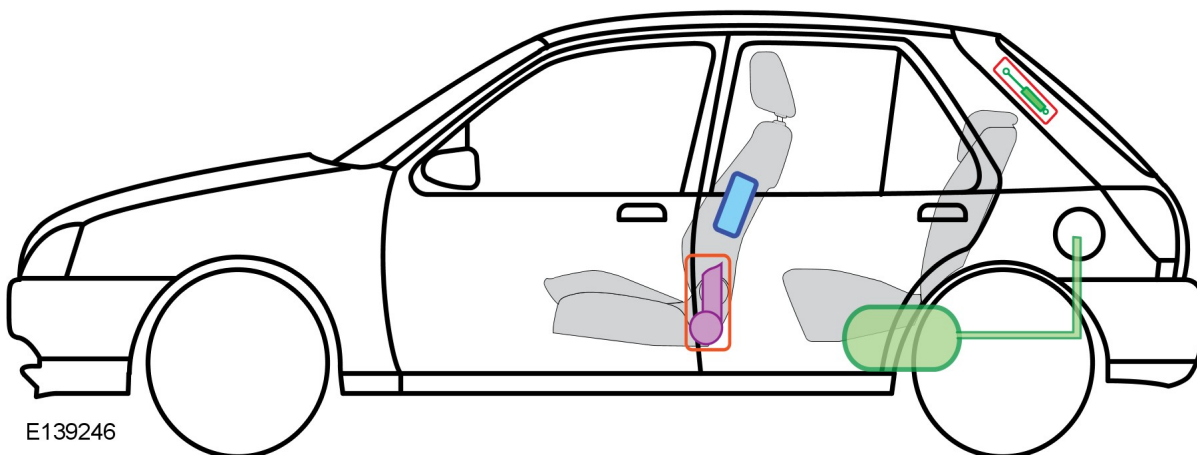
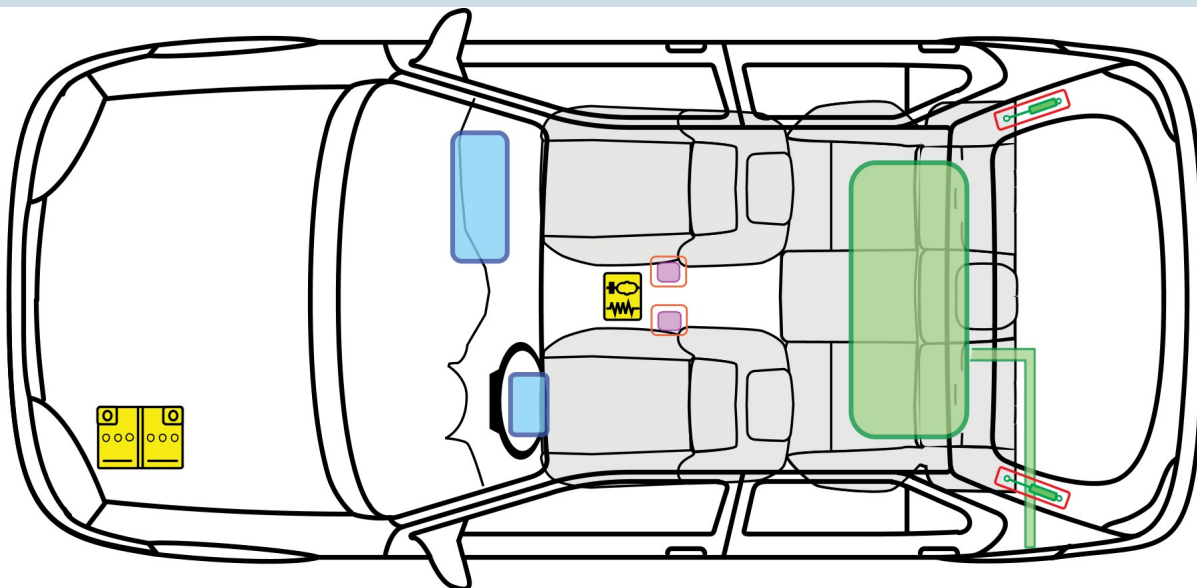

E139246

Legenda

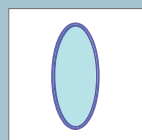

Ochronna poduszka powietrzna

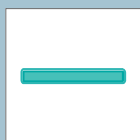

Wzmocnienia konstrukcji



Sterownik

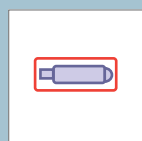

Generator gazu



Aktywna ochrona w przypadku wywrócenia pojazdu
Sprężyna gazowa

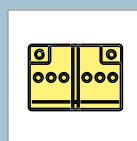

Akumulator

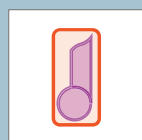

Napinacze pasów

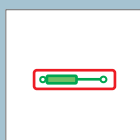

Zbiornik paliwa



Ford Fiesta

Wersja 3-drzwiowa



E136850



06/2008 – >

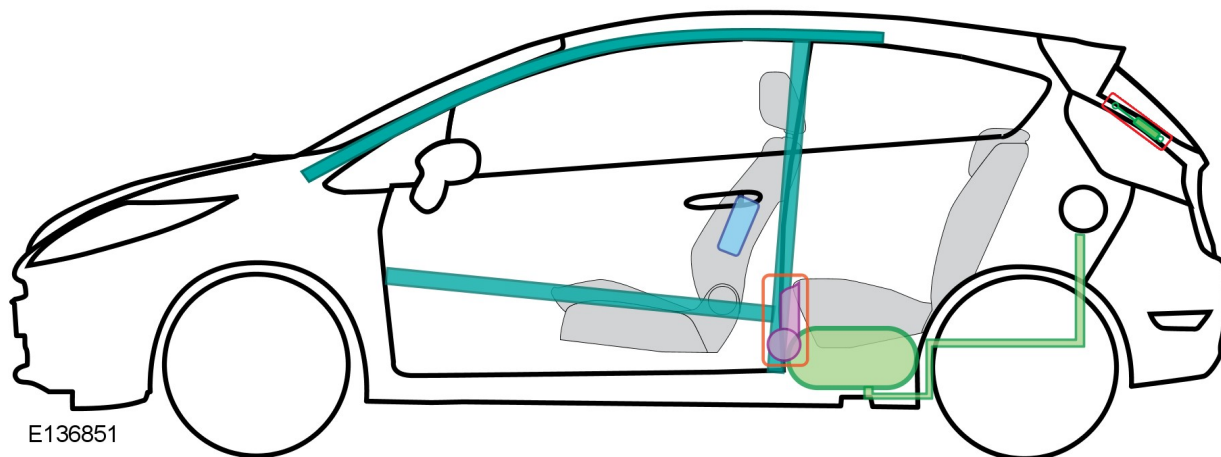
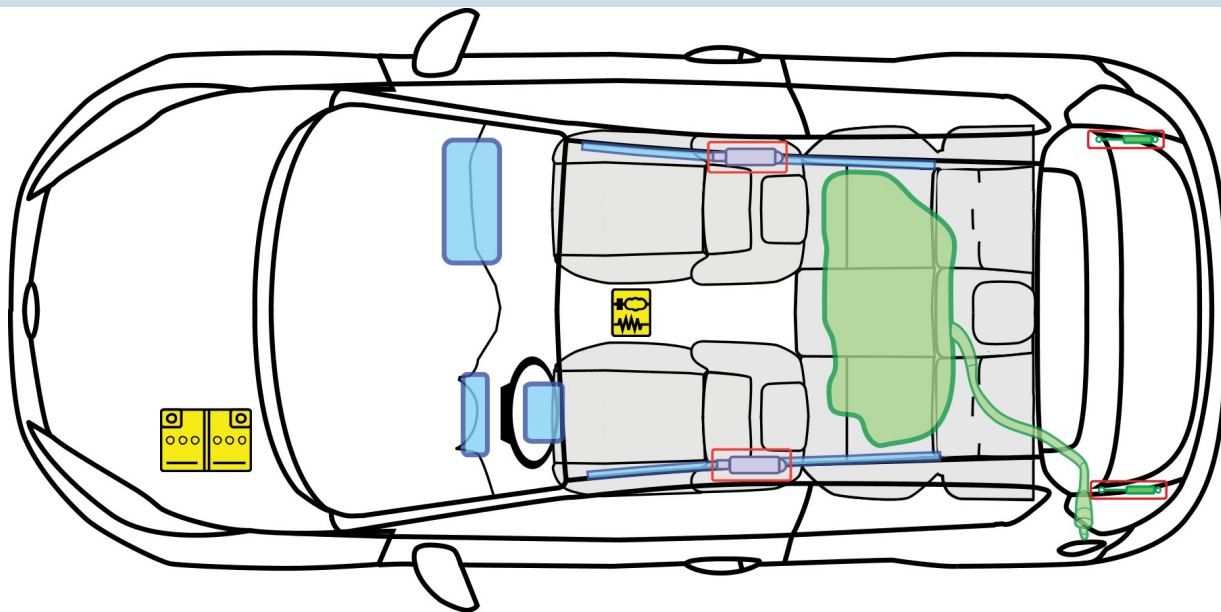

E136851

Legenda

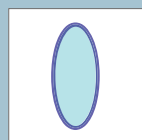

Ochronna poduszka powietrzna

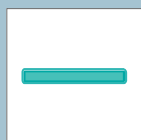

Wzmocnienia konstrukcji



Sterownik

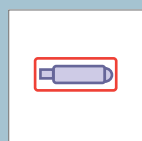

Generator gazu

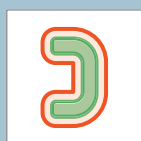

Aktywna ochrona w przypadku wywrócenia pojazdu
Sprężyna gazowa

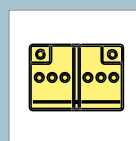

Akumulator

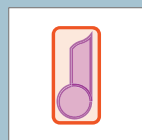

Napinaczy pasów

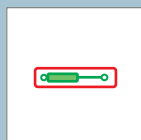

Zbiornik paliwa



Ford Fiesta

Wersja 3-drzwiowa



E138545

11/2001 – 09/2008

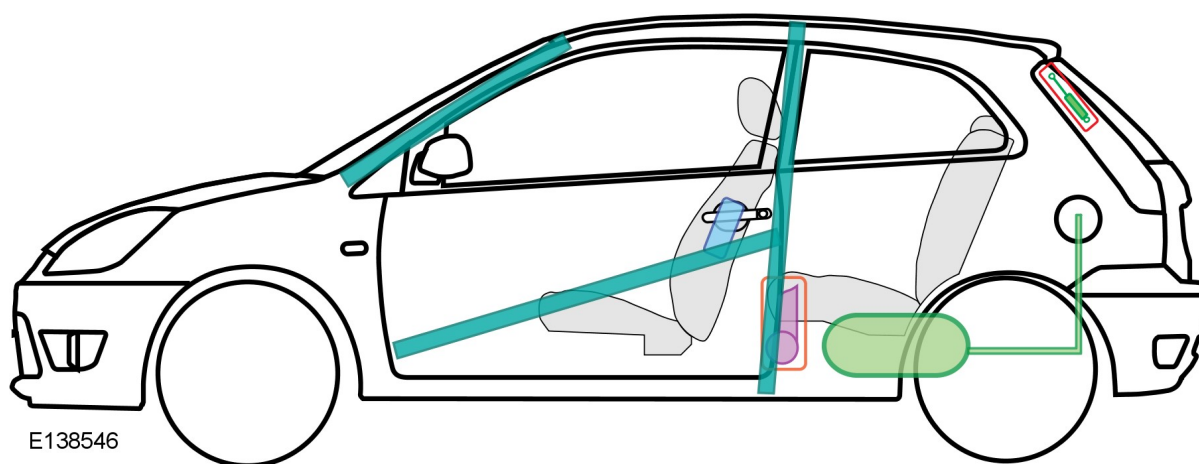
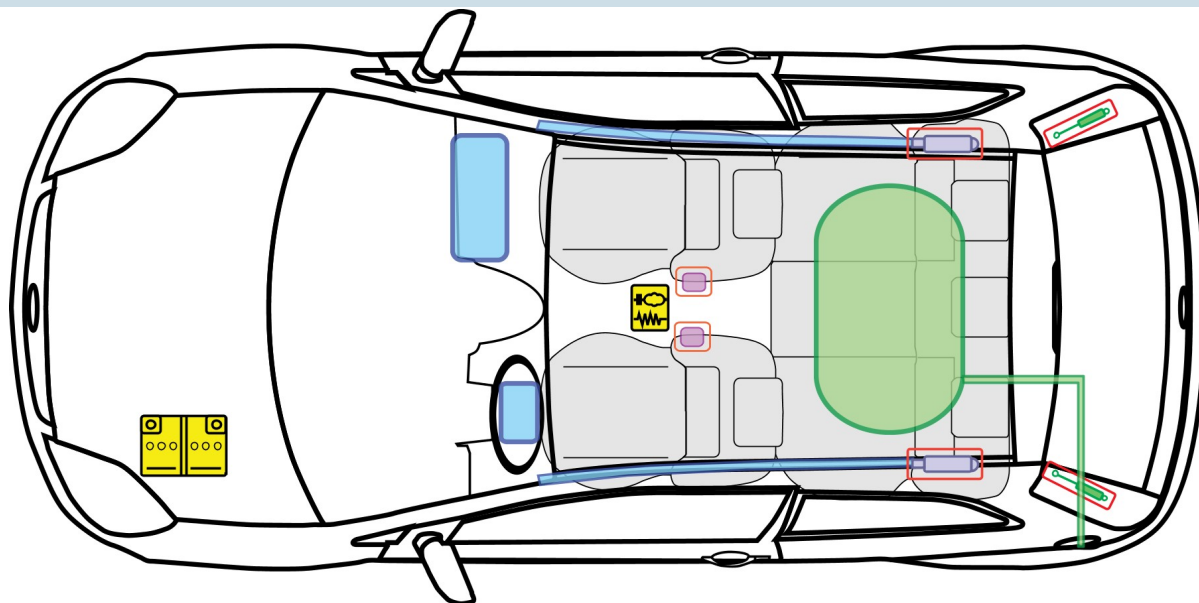

E138546

Legenda

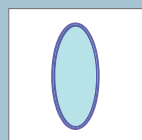

Ochronna poduszka powietrzna

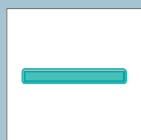

Wzmocnienia konstrukcji



Sterownik

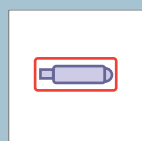

Generator gazu

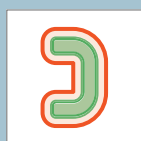

Aktywna ochrona w przypadku wywrócenia pojazdu

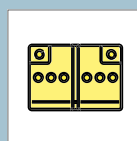

Akumulator

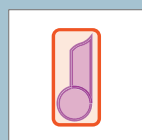

Napinacze pasów

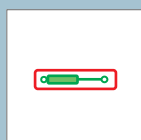

Sprężyna gazowa



Zbiornik paliwa

Ford Fiesta - LPG

Wersja 3-drzwiowa



E136850



06/2008 - >

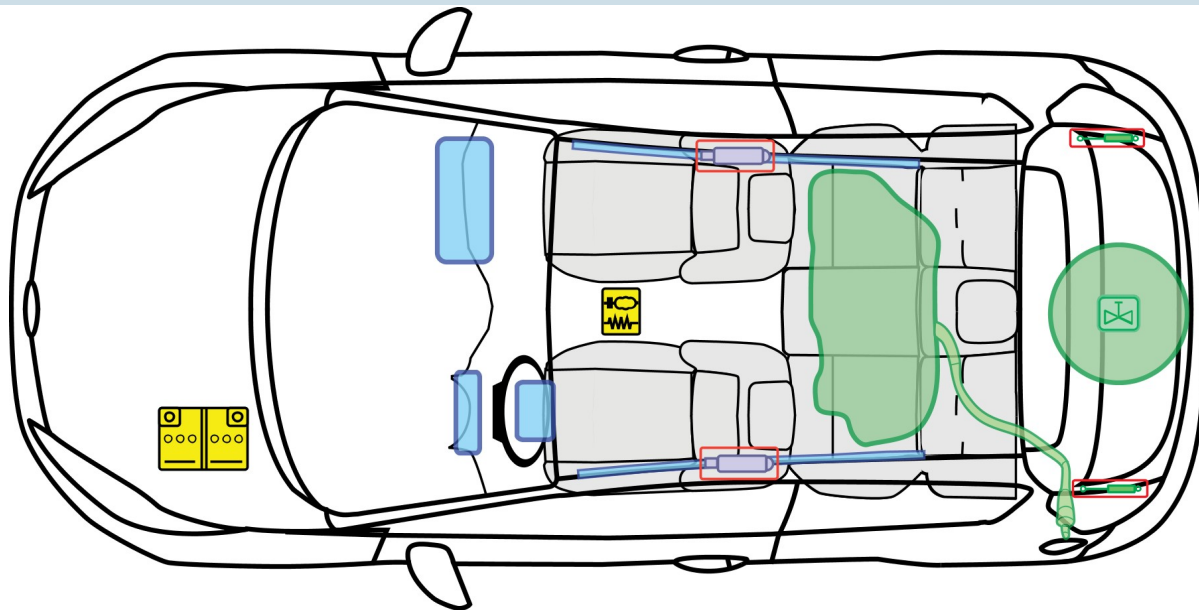

LPG

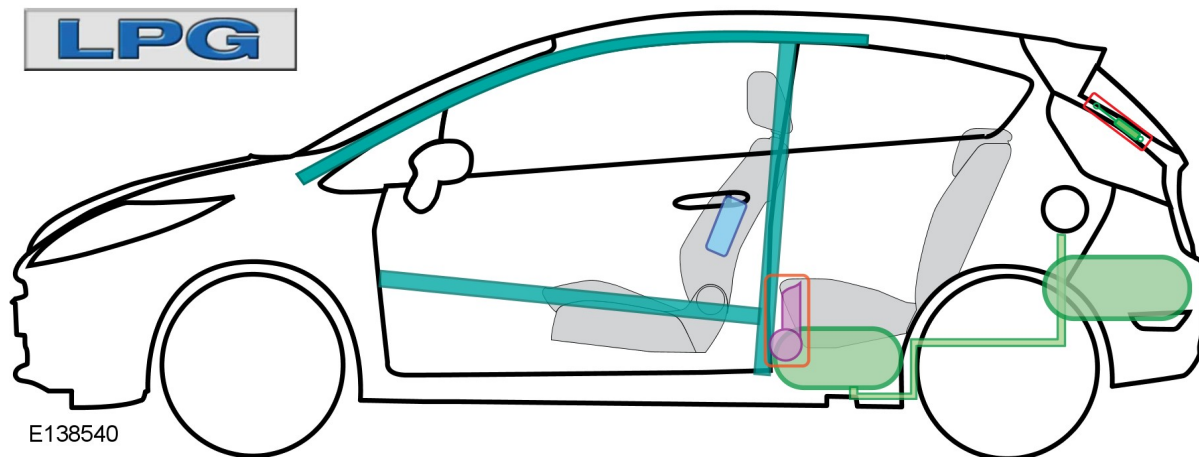

E138540

Legenda

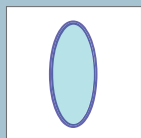

Ochronna poduszka powietrzna

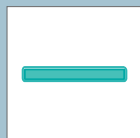

Wzmocnienia konstrukcji



Sterownik



Generator gazu



Aktywna ochrona w przypadku wywrócenia pojazdu
Sprężyna gazowa

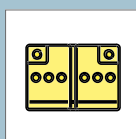

Akumulator



Zbiornika gazu

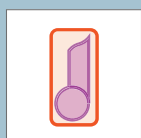

Napinaczy pasów

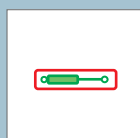

Zbiornik paliwa



Zawór bezpieczeństwa

Ford Fiesta

Wersja 5-drzwiowa



E136848

11/2001 – 09/2008

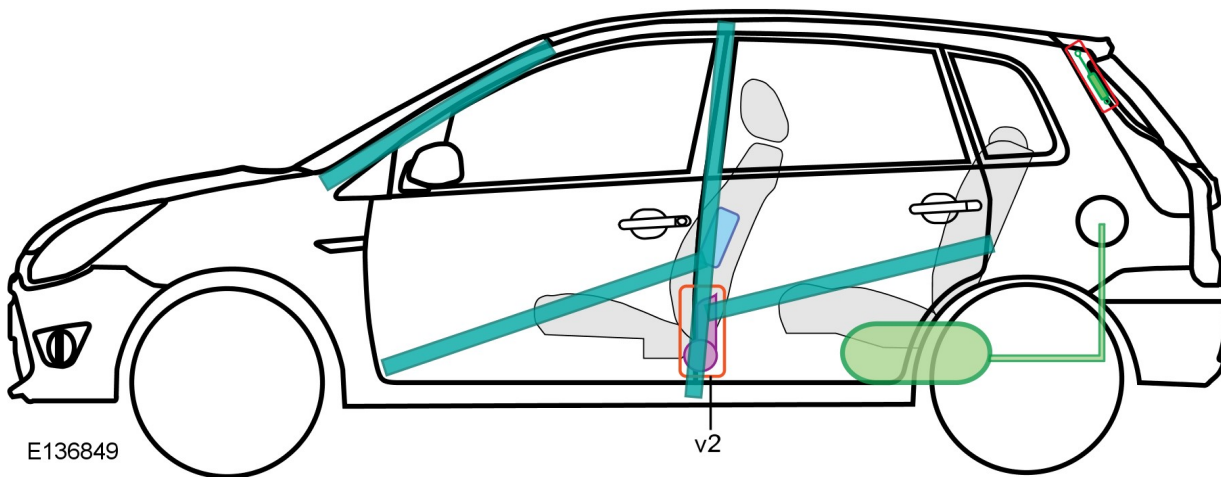
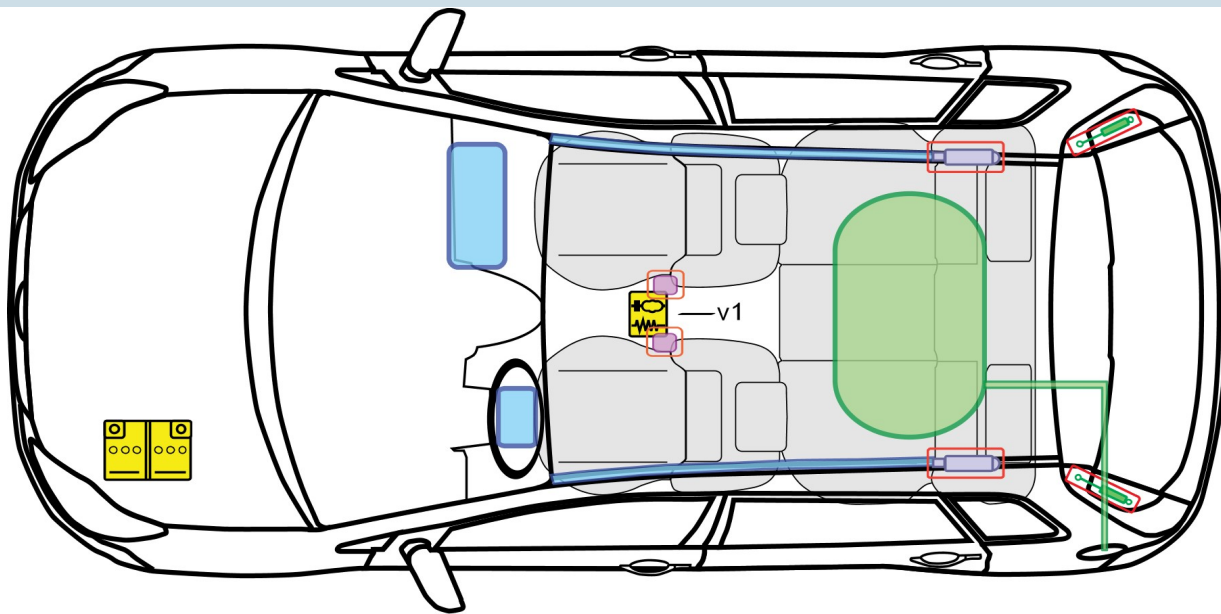

E136849

Legenda

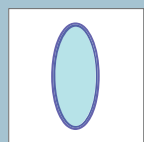

Ochronna poduszka powietrzna

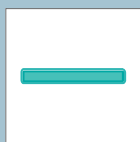

Wzmocnienia konstrukcji



Sterownik

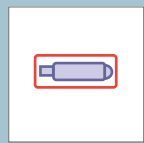

Generator gazu



Aktywna ochrona w przypadku wywrócenia pojazdu

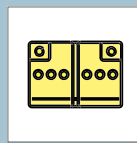

Akumulator

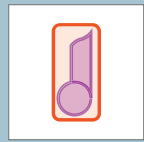

Napinacze pasów

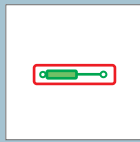

Sprężyna gazowa



Zbiornik paliwa



Ford Fiesta

Wersja 5-drzwiowa

E138536



06/2008 – >

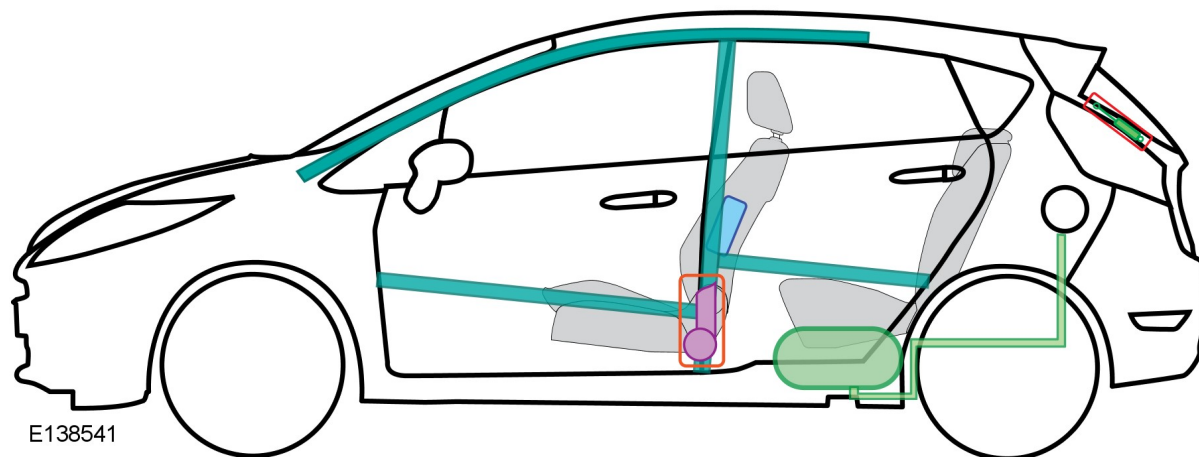
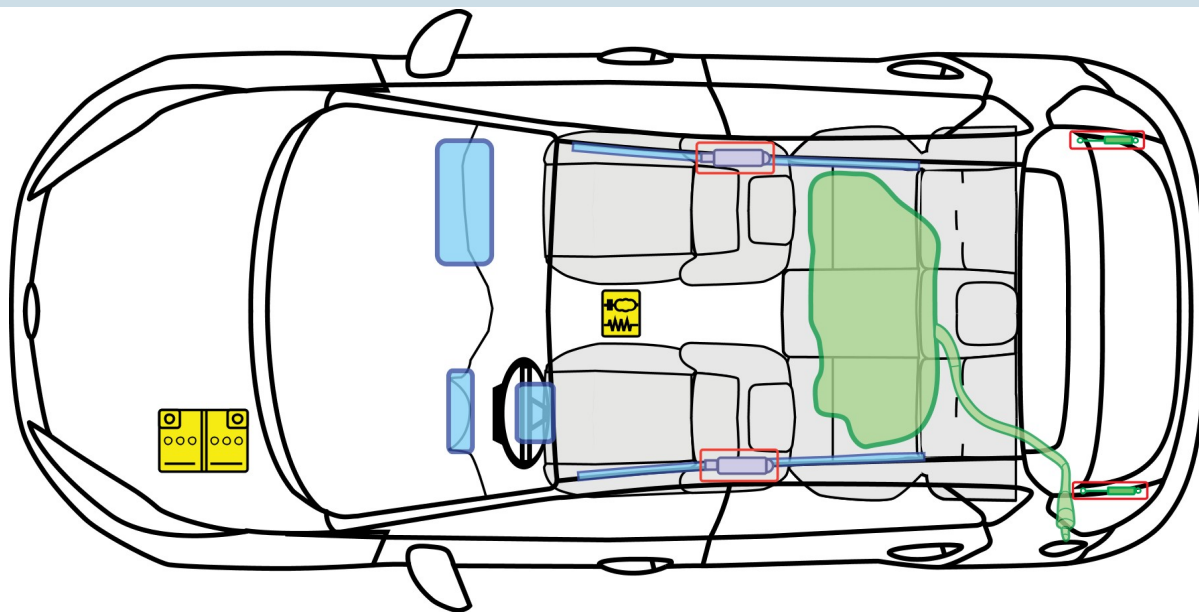

E138541

Legenda

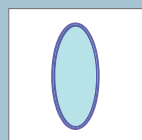

Ochronna poduszka powietrzna

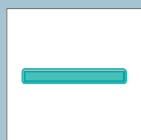

Wzmocnienia konstrukcji



Sterownik

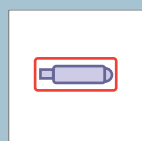

Generator gazu

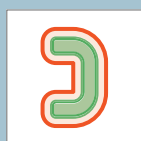

Aktywna ochrona w przypadku wywrócenia pojazdu

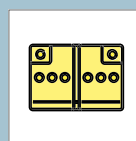

Akumulator

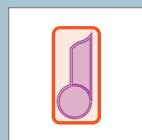

Napinacze pasów

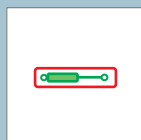

Sprężyna gazowa



Zbiornik paliwa

F

Ford Fiesta - LPG

Wersja 5-drzwiowa

E138536



06/2008 - >

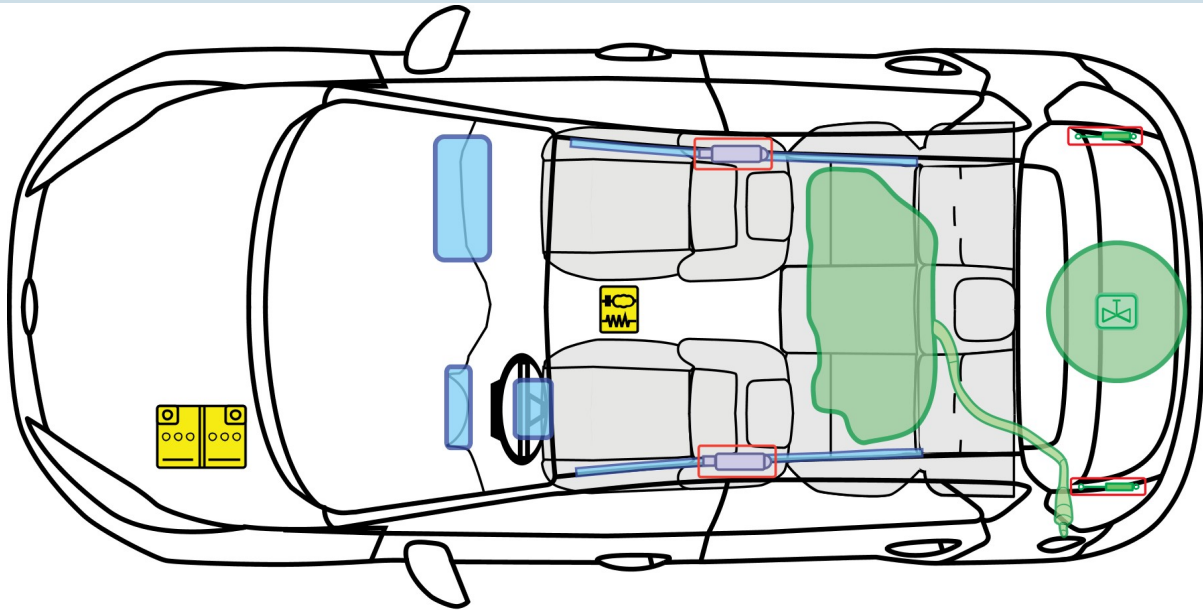

LPG

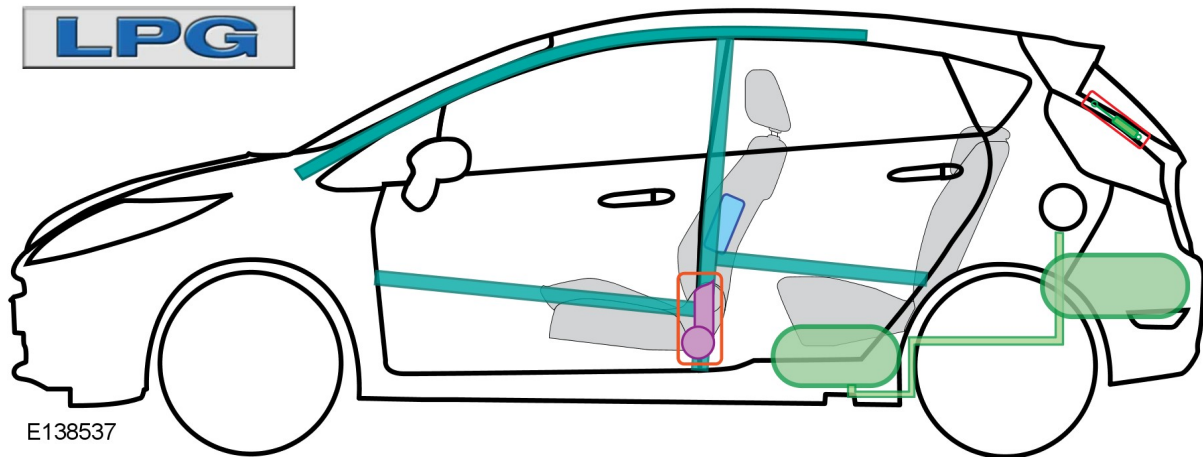

E138537

Legenda

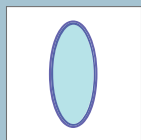

Ochronna poduszka powietrzna

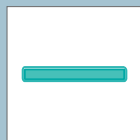

Wzmocnienia konstrukcji



Sterownik

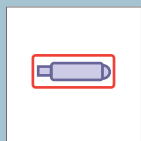

Generator gazu



Aktywna ochrona w przypadku wywrócenia pojazdu
Sprężyna gazowa

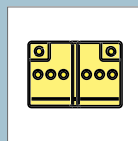

Akumulator



Zbiornika gazu

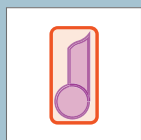

Napinacze pasów

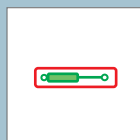

Zbiornik paliwa



Zawór bezpieczeństwa

Ford Focus Kombi



E137222

07/2004 – 08/2007

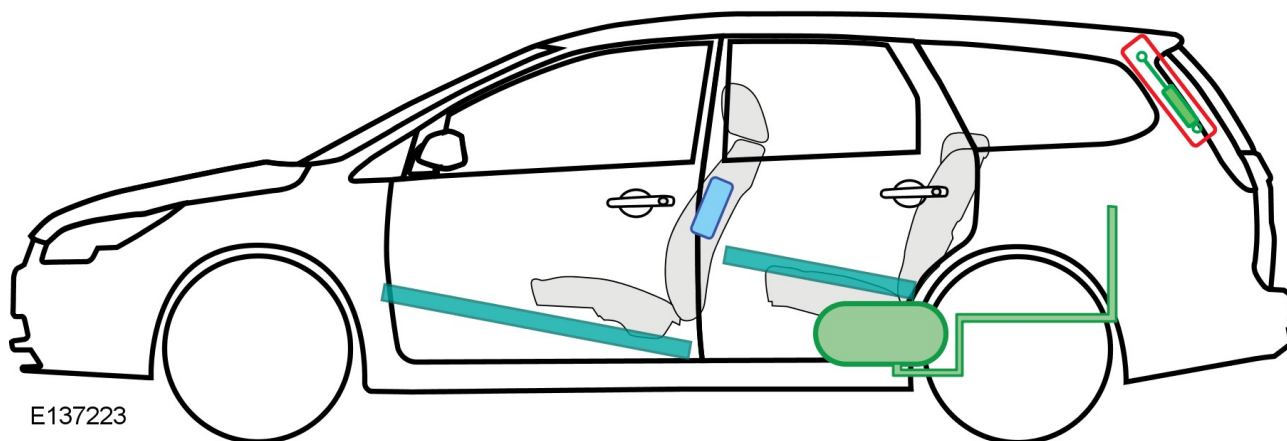
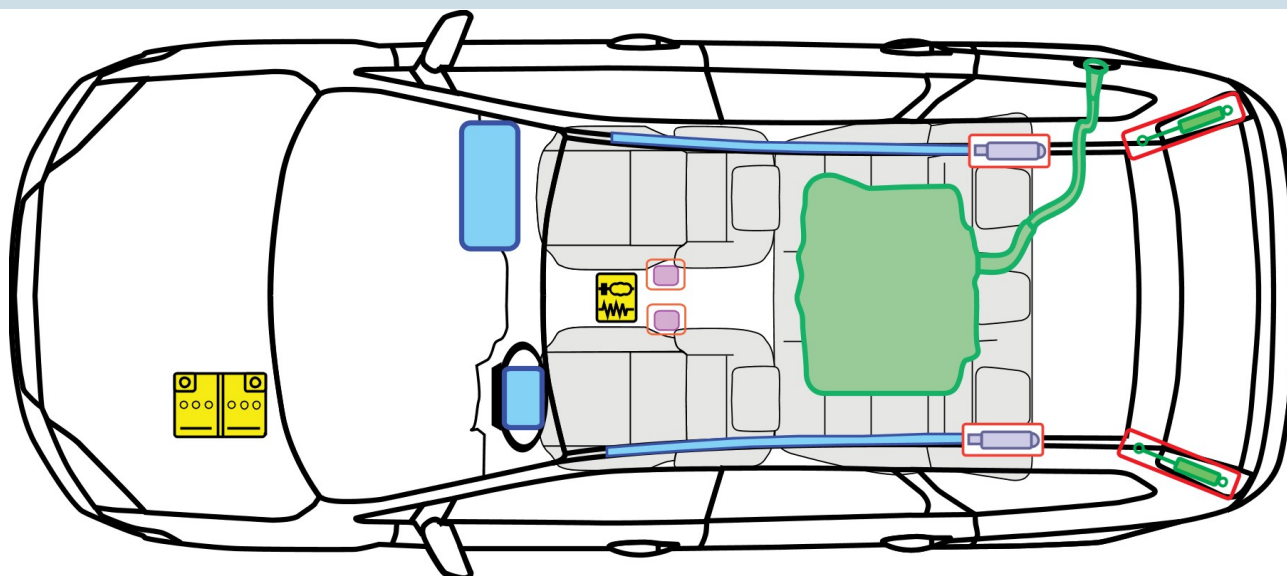

E137223

Legenda

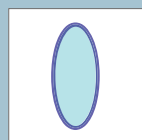

Ochronna poduszka powietrzna

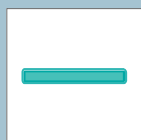

Wzmocnienia konstrukcji



Sterownik

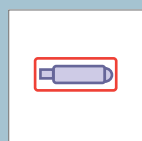

Generator gazu

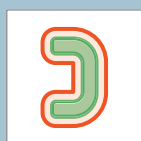

Aktywna ochrona w przypadku wywrócenia pojazdu
Sprężyna gazowa

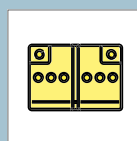

Akumulator

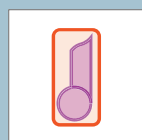

Napinacze pasów



Zbiornik paliwa

Ford Focus Kombi



E137991

08/2007 – 03/2011

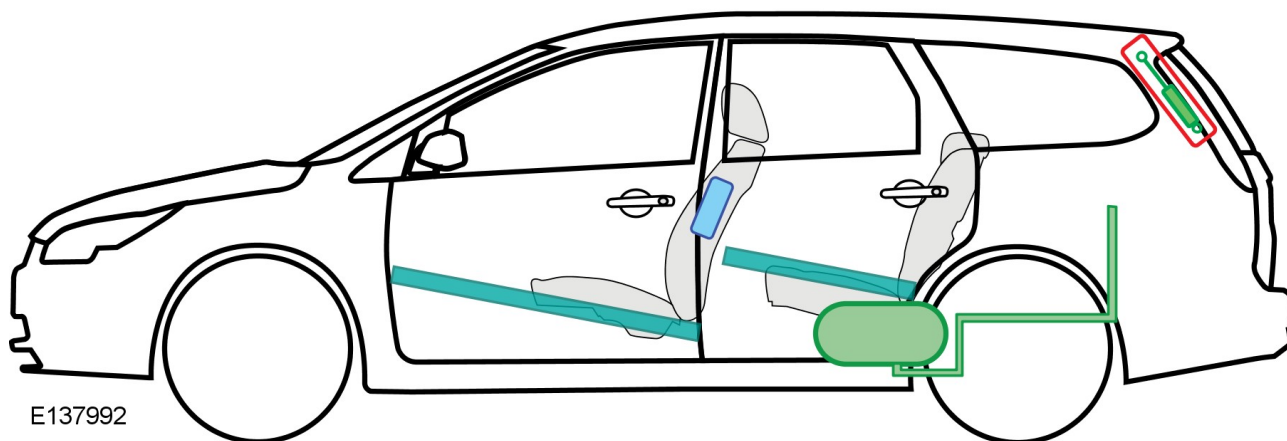
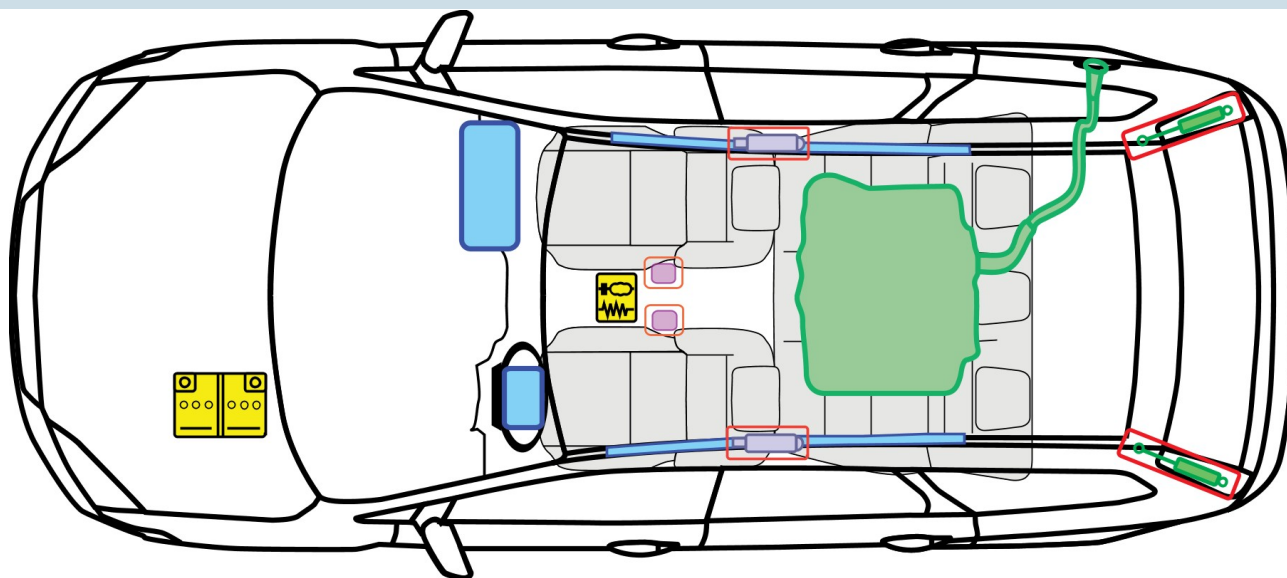

E137992

Legenda

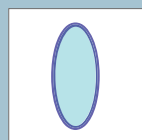

Ochronna poduszka powietrzna

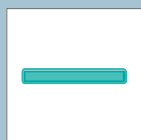

Wzmocnienia konstrukcji



Sterownik

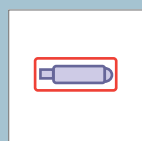

Generator gazu

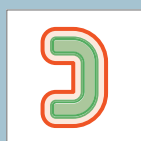

Aktywna ochrona w przypadku wywrócenia pojazdu
Sprężyna gazowa

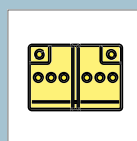

Akumulator

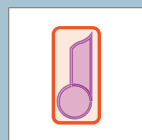

Napinacze pasów

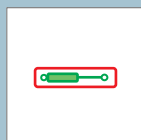

Zbiornik paliwa

F

Ford Focus Kombi



E138505

08/1998 – 12/2004

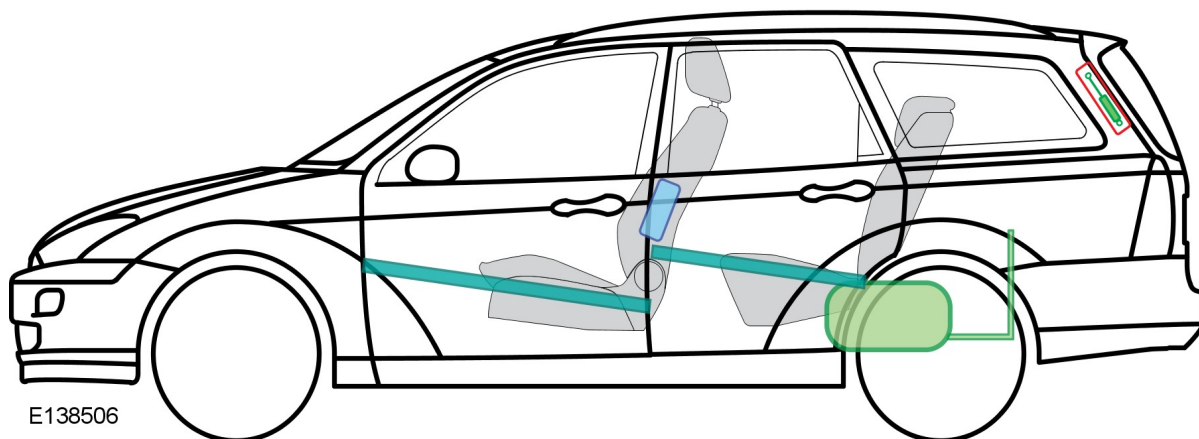
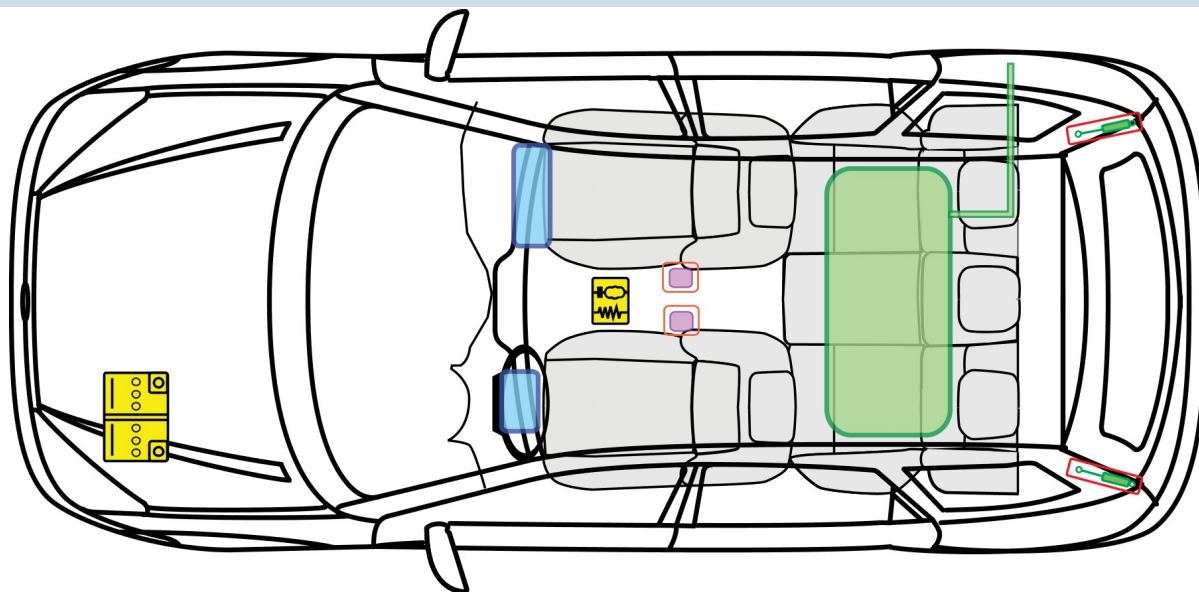

E138506

Legenda

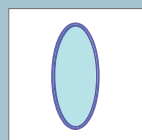

Ochronna poduszka powietrzna

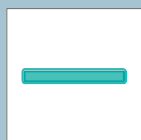

Wzmocnienia konstrukcji



Sterownik

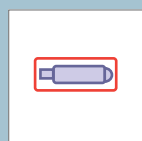

Generator gazu

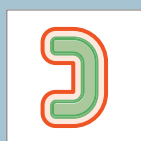

Aktywna ochrona w przypadku wywrócenia pojazdu
Sprężyna gazowa

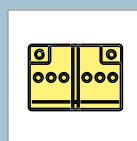

Akumulator

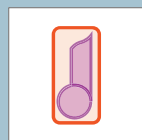

Napinacze pasów

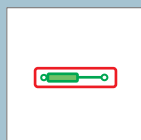

Zbiornik paliwa





E139114

03/2011 – >

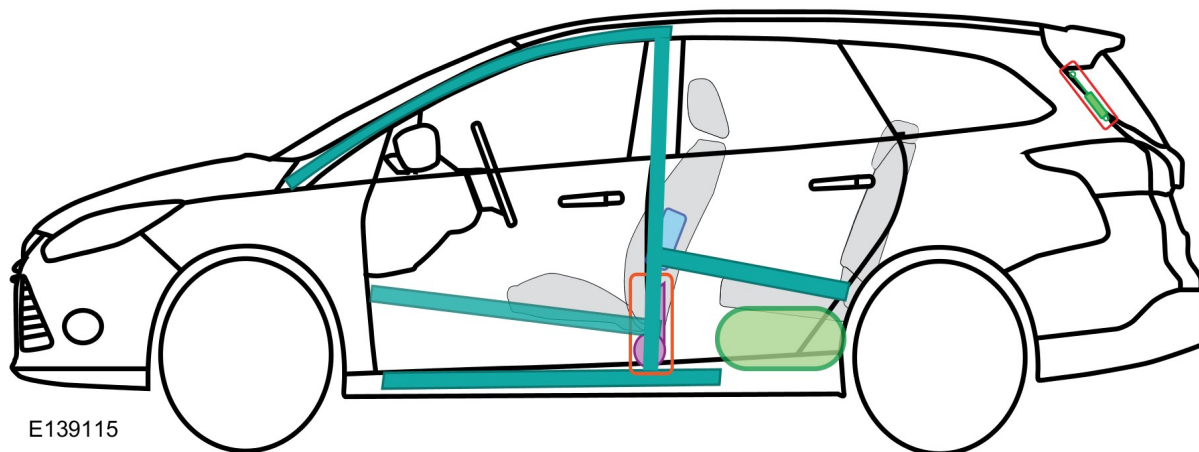
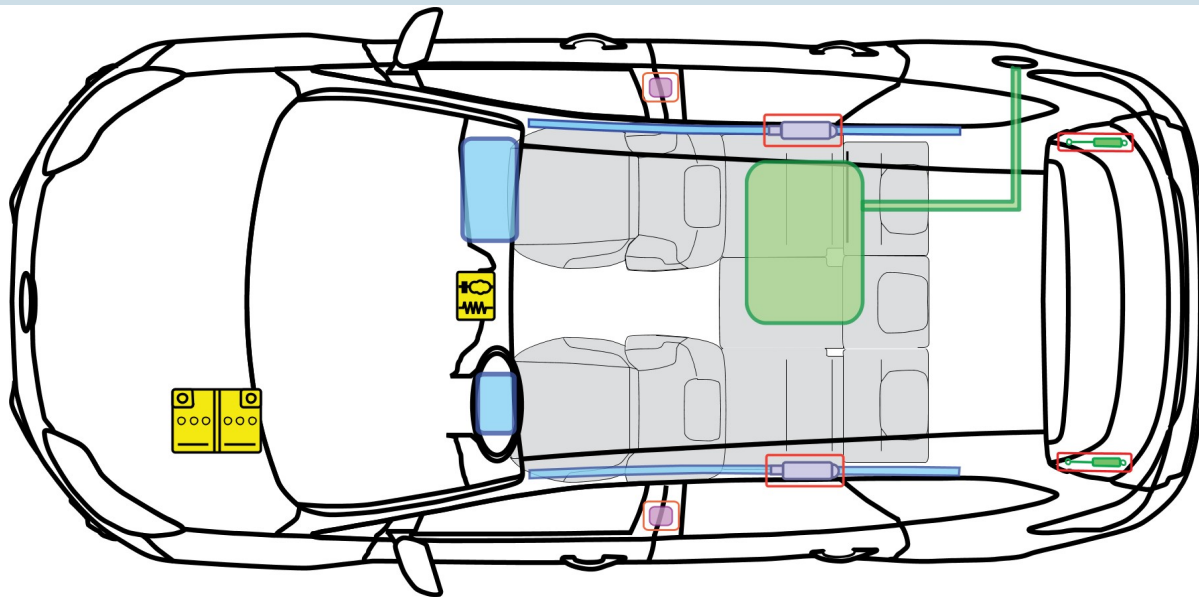

E139115

Legenda

	Ochrona poduszka powietrzna		Wzmocnienia konstrukcji		Sterownik
	Generator gazu		Aktywna ochrona w przypadku wywrócenia pojazdu		Akumulator
	Napinacze pasów		Sprężyna gazowa		Zbiornik paliwa



Ford Focus - LPG Kombi



E137991



08/2007 – 03/2011

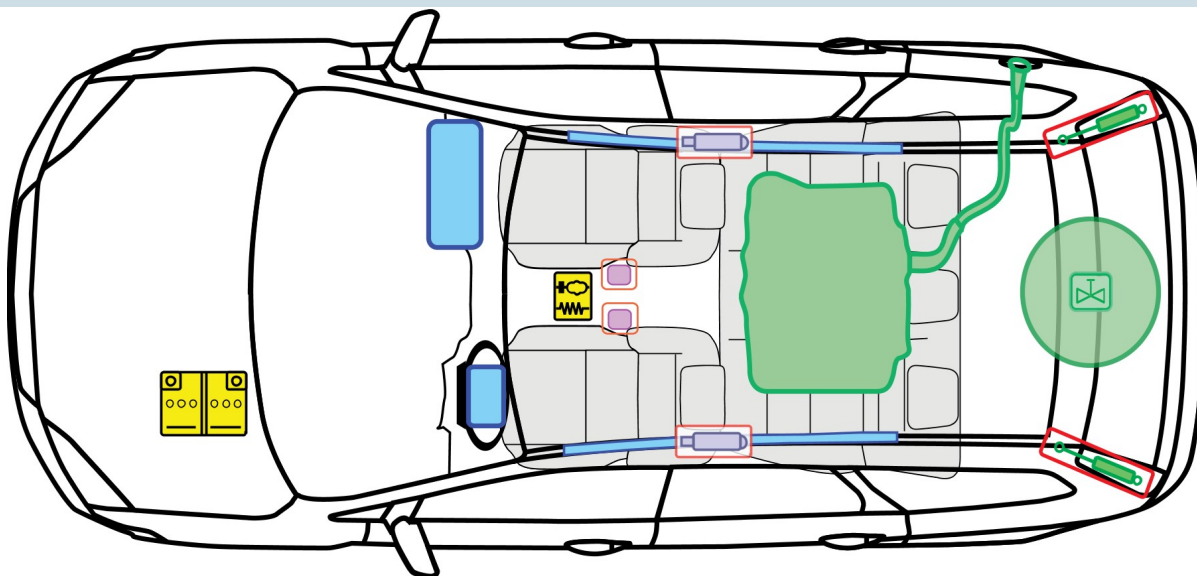

LPG

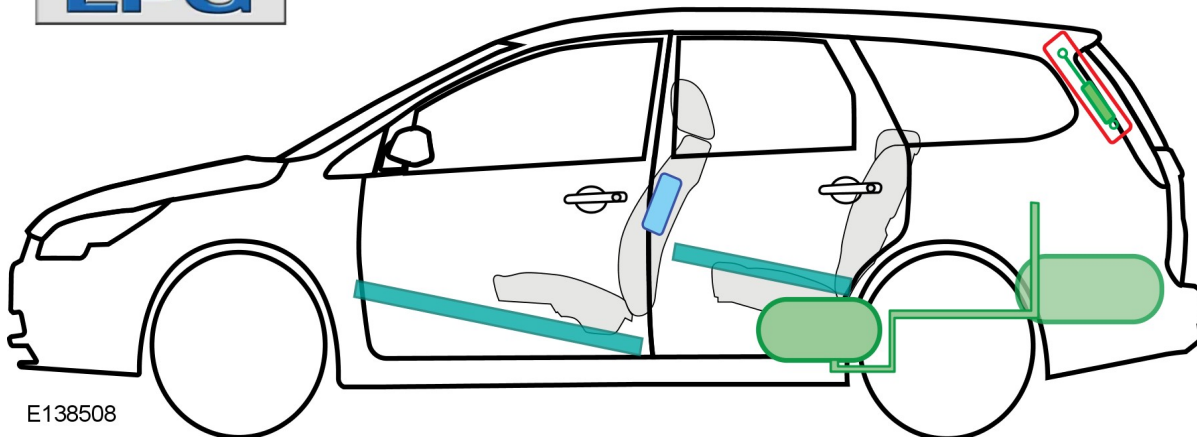

E138508

Legenda

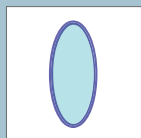

Ochronna poduszka powietrzna

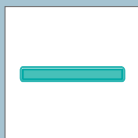

Wzmocnienia konstrukcji



Sterownik



Generator gazu



Aktywna ochrona w przypadku wywrócenia pojazdu
Sprężyna gazowa

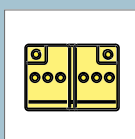

Akumulator



Zbiornika gazu

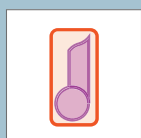

Napinaczy pasów



Zbiornik paliwa



Zawór bezpieczeństwa

Ford Focus - LPG Kombi



E137222

07/2004 – 08/2007

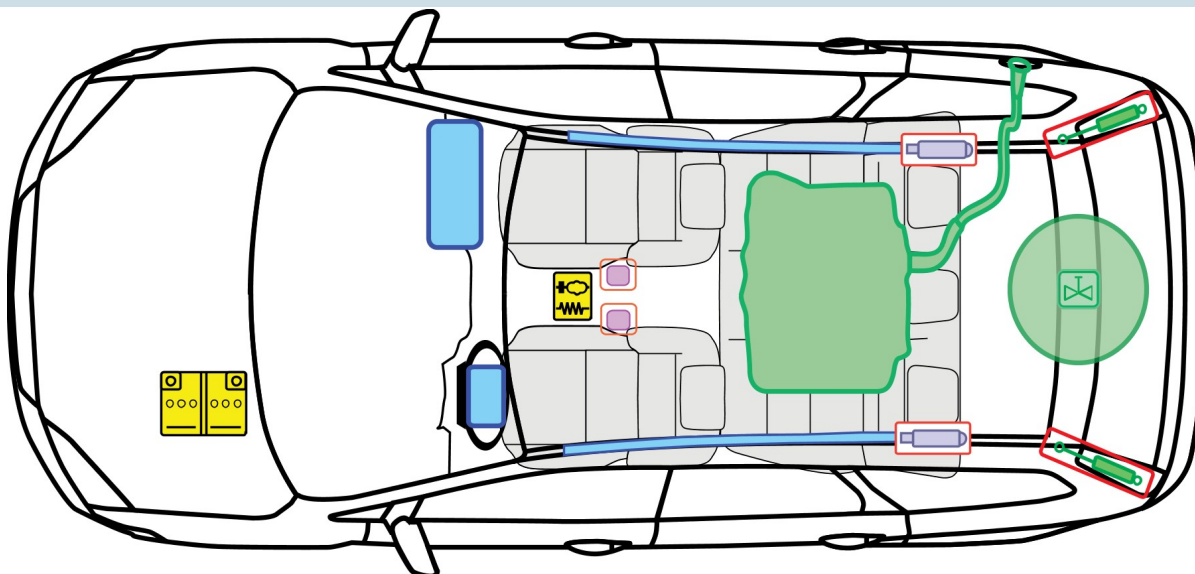

LPG

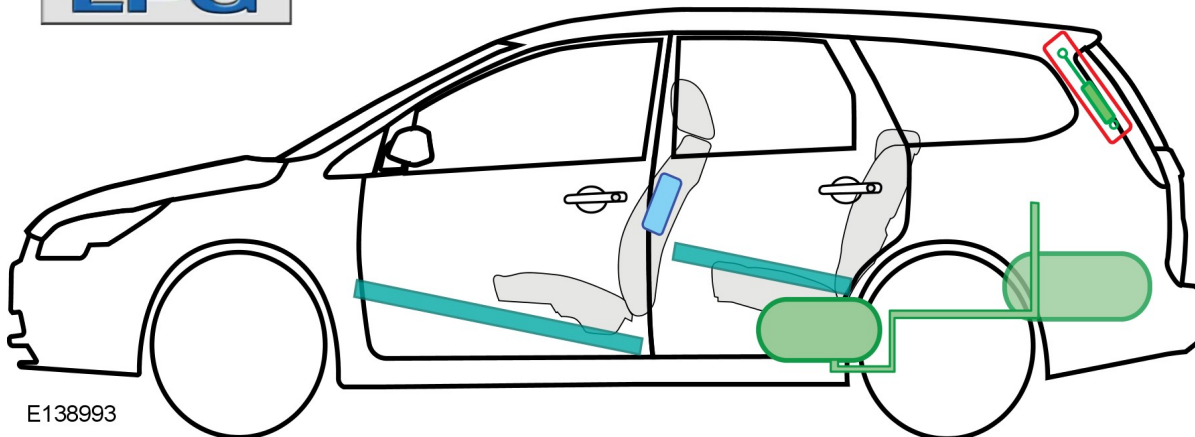

E138993

Legenda

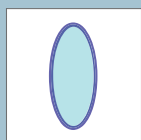

Ochronna poduszka powietrzna

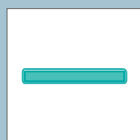

Wzmocnienia konstrukcji



Sterownik

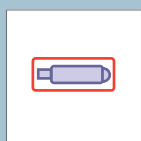

Generator gazu



Aktywna ochrona w przypadku wywrócenia pojazdu
Sprężyna gazowa

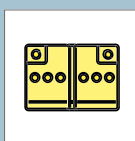

Akumulator



Zbiornika gazu

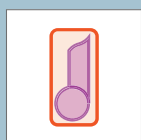

Napinaczy pasów

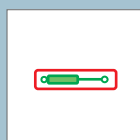

Zbiornik paliwa

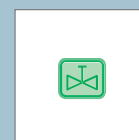

Zawór bezpieczeństwa

Ford Focus - LPG Kombi



E139114

05/2012 – >

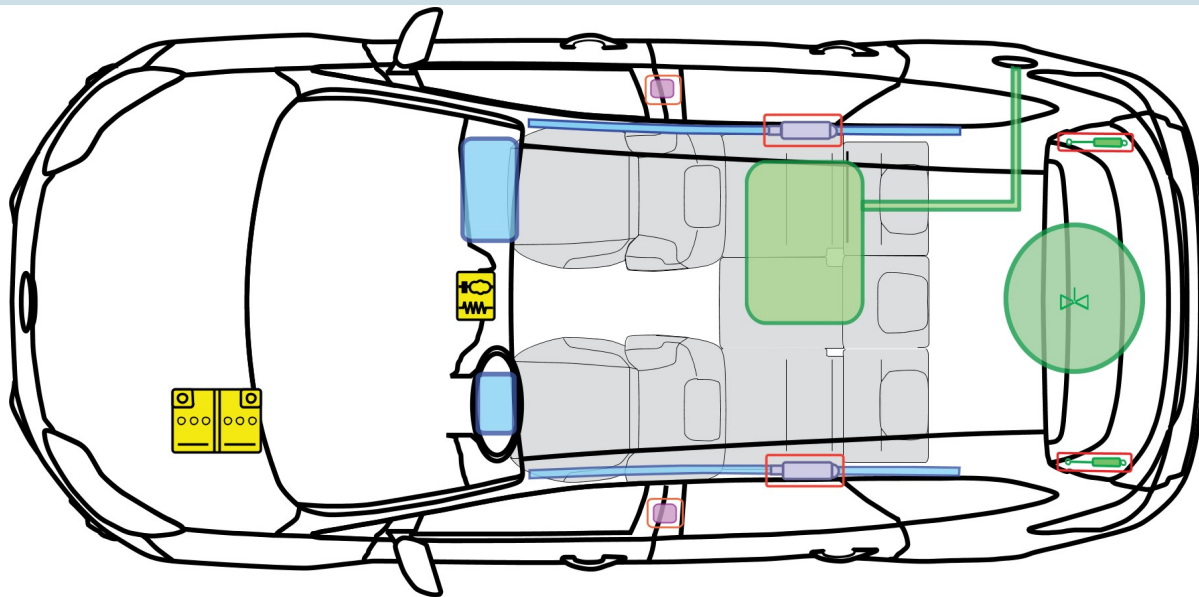

LPG

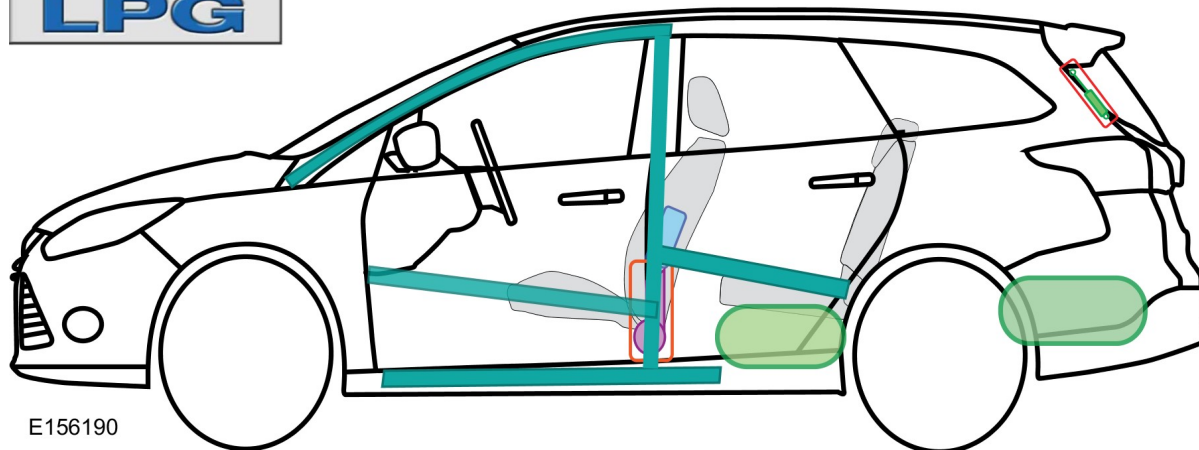

E156190

Legenda

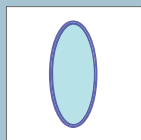

Ochronna poduszka powietrzna

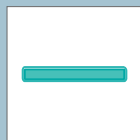

Wzmocnienia konstrukcji



Sterownik

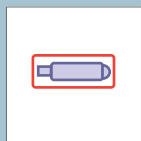

Generator gazu



Aktywna ochrona w przypadku wywrócenia pojazdu
Sprężyna gazowa

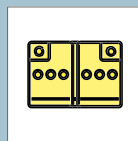

Akumulator



Zbiornika gazu

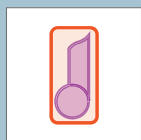

Napinaczy pasów

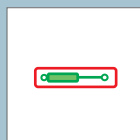

Zbiornik paliwa



Zawór bezpieczeństwa

FordFocus Składany



E137308

03/2007 – 07/2010

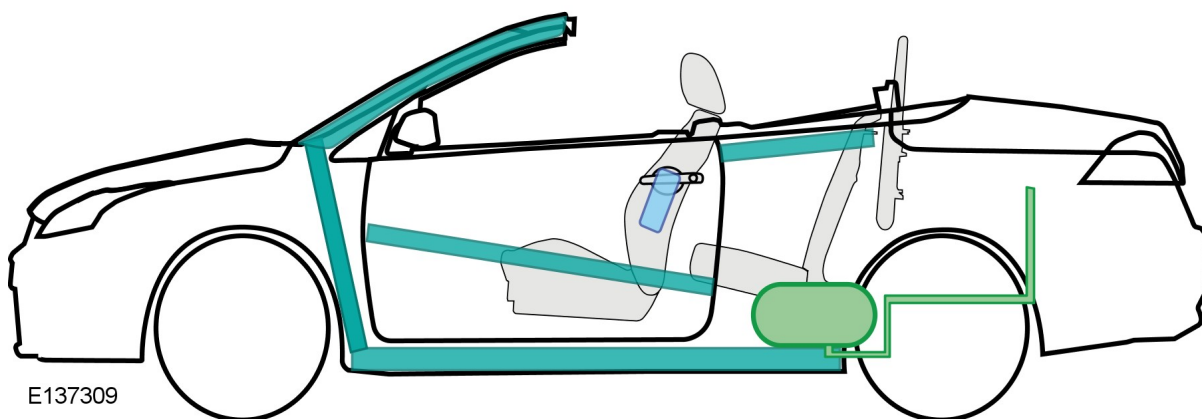
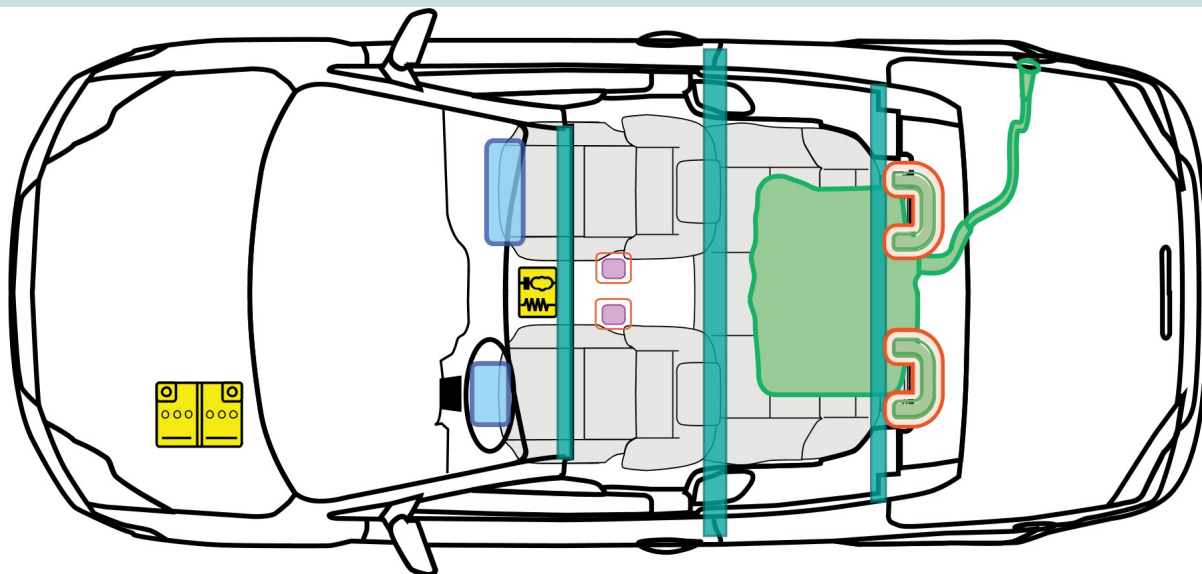

E137309

Legenda

F

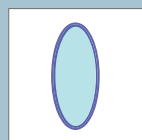

Ochronna poduszka powietrzna

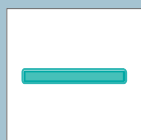

Wzmocnienia konstrukcji



Sterownik

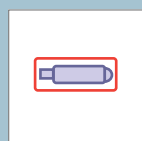

Generator gazu

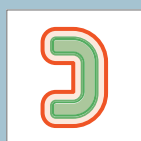

Aktywna ochrona w przypadku wywrócenia pojazdu
Sprężyna gazowa

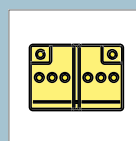

Akumulator

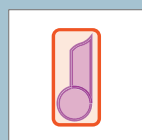

Napinaczy pasów

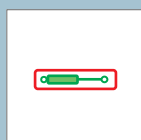

Zbiornik paliwa

FordFocus

Wersja 3-drzwiowa



E137212

07/2004 – 08/2007

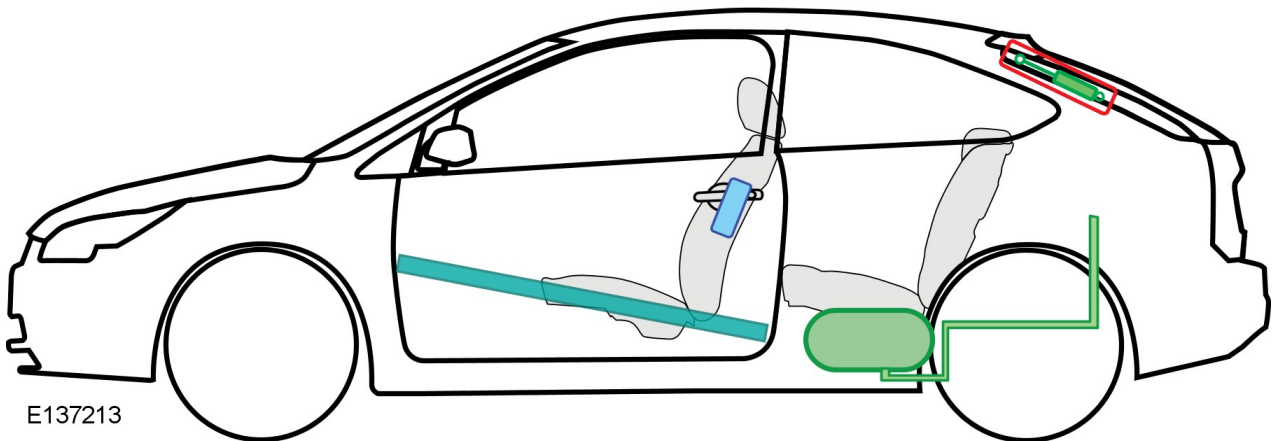
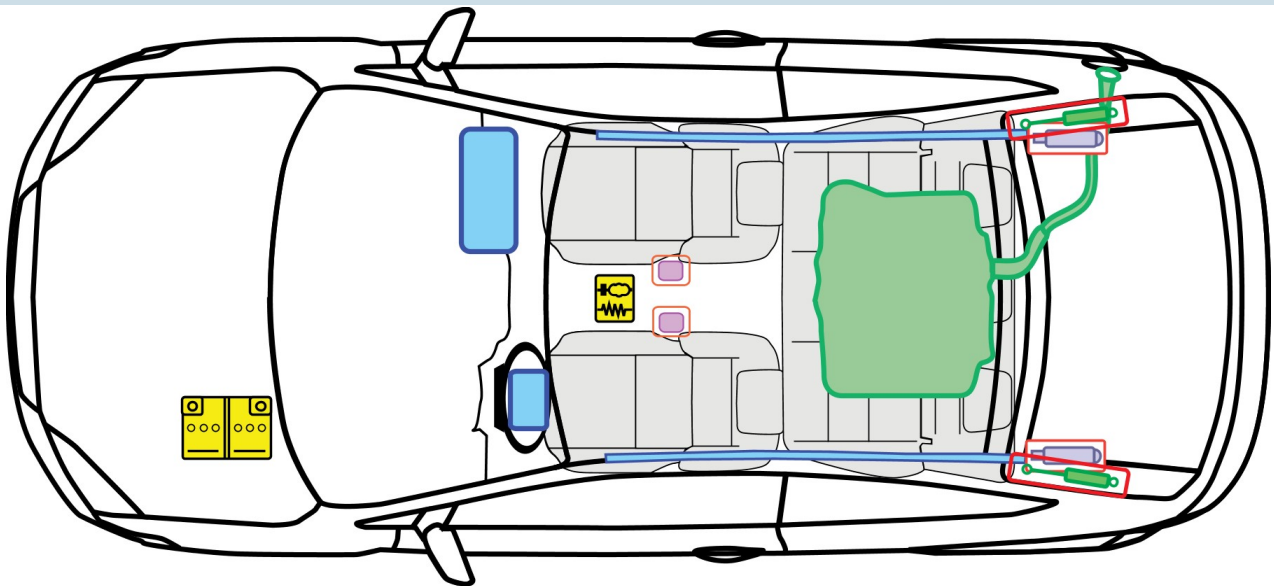

E137213

Legenda

	Ochronna poduszka powietrzna		Wzmocnienia konstrukcji		Sterownik
	Generator gazu		Aktywna ochrona w przypadku wywrócenia pojazdu		Akumulator
	Napinacze pasów		Sprężyna gazowa		Zbiornik paliwa

F

FordFocus

Wersja 3-drzwiowa



E137224

08/2007 – 03/2011

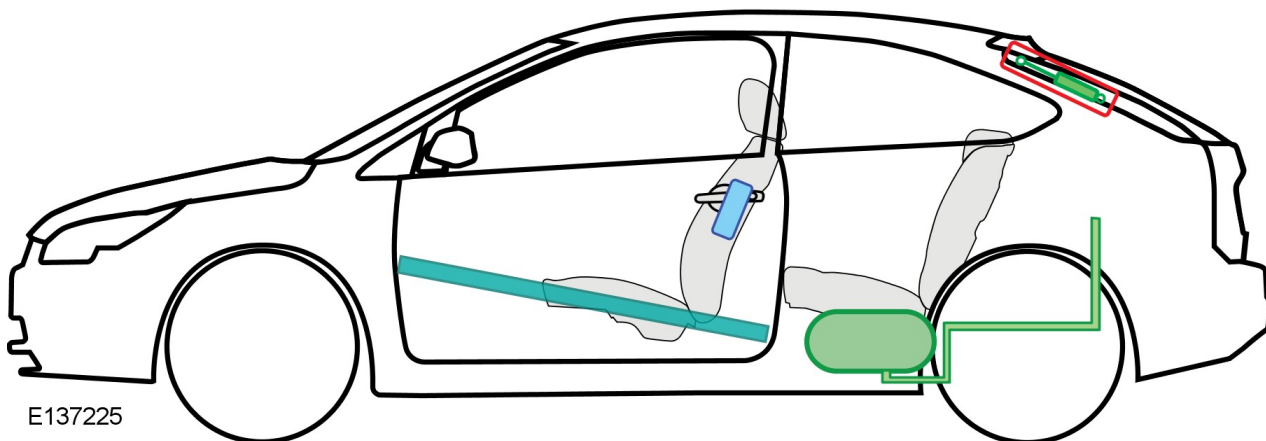
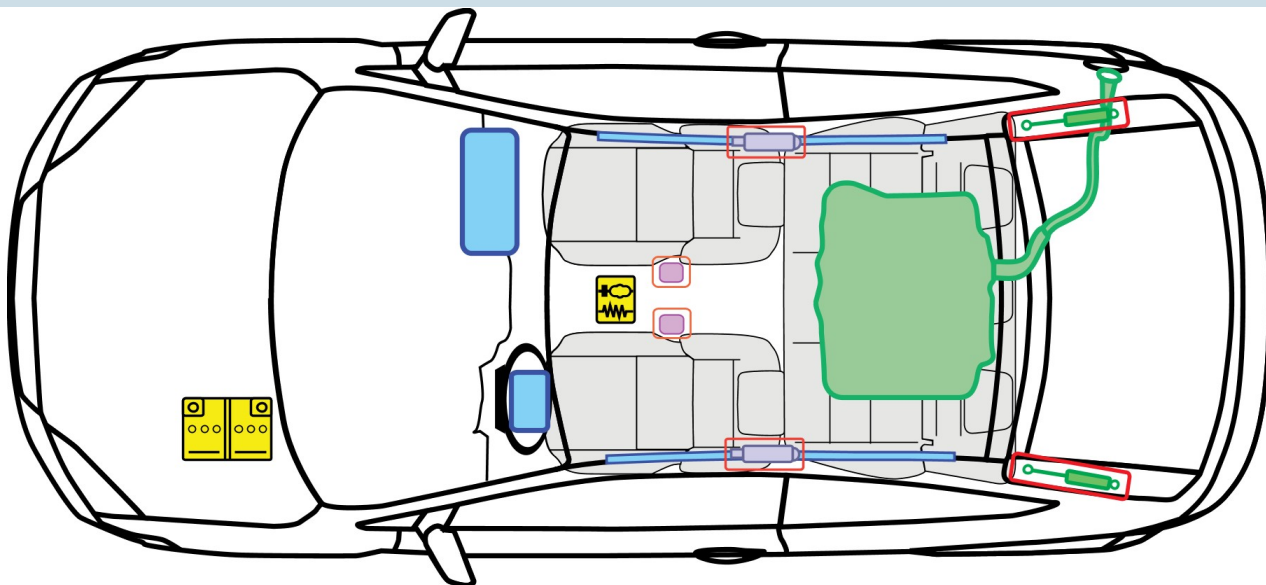

E137225

Legenda

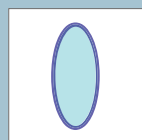

Ochronna poduszka powietrzna

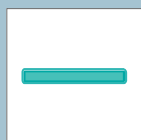

Wzmocnienia konstrukcji



Sterownik

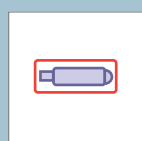

Generator gazu



Aktywna ochrona w przypadku wywrócenia pojazdu
Sprężyna gazowa

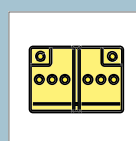

Akumulator

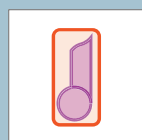

Napinaczy pasów



Zbiornik paliwa

Ford Focus

Wersja 3-drzwiowa

E137208



08/1998 – 12/2004

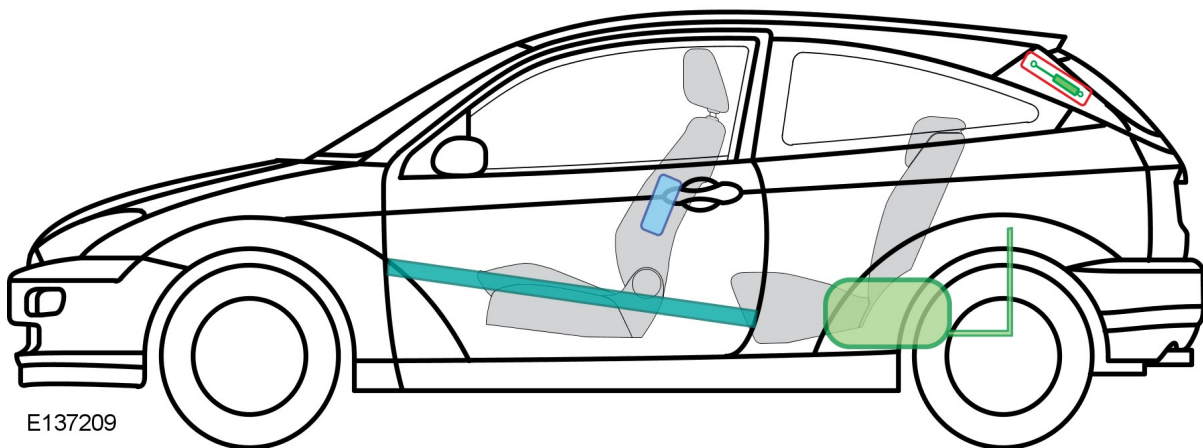
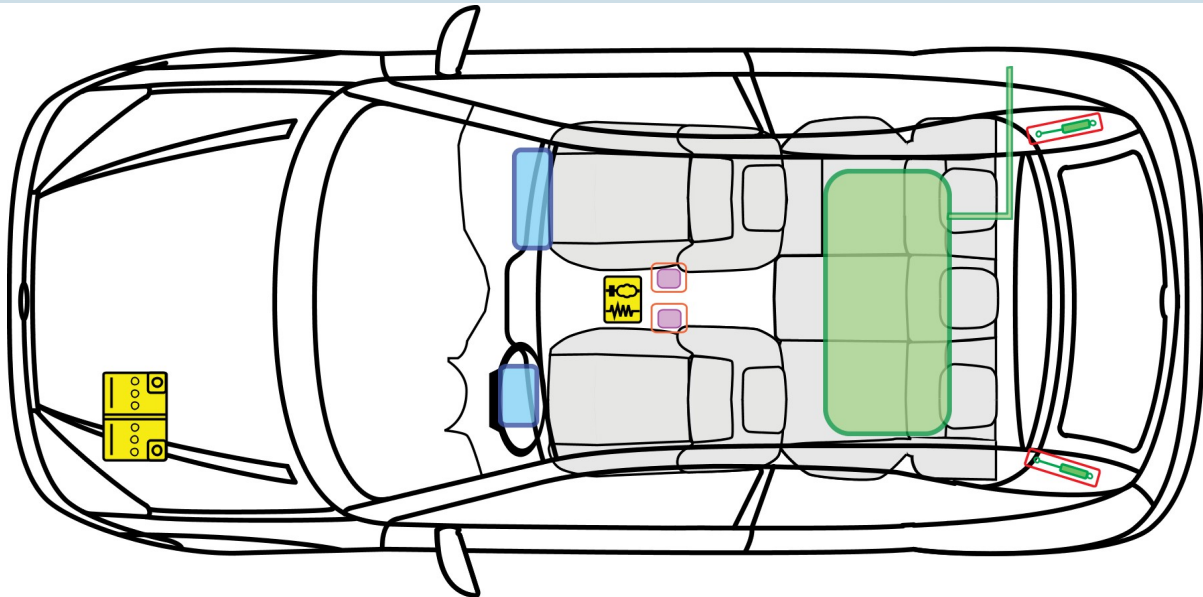

E137209

Legenda

F

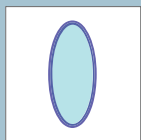

Ochronna poduszka powietrzna

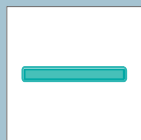

Wzmocnienia konstrukcji



Sterownik

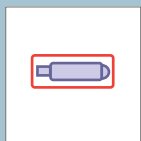

Generator gazu



Aktywna ochrona w przypadku wywrócenia pojazdu
Sprężyna gazowa

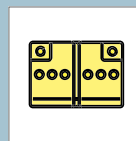

Akumulator

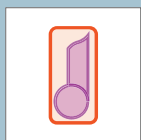

Napinacze pasów

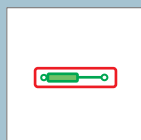

Zbiornik paliwa



FordFocus - LPG

Wersja 3-drzwiowa



E137224

08/2007 – 03/2011

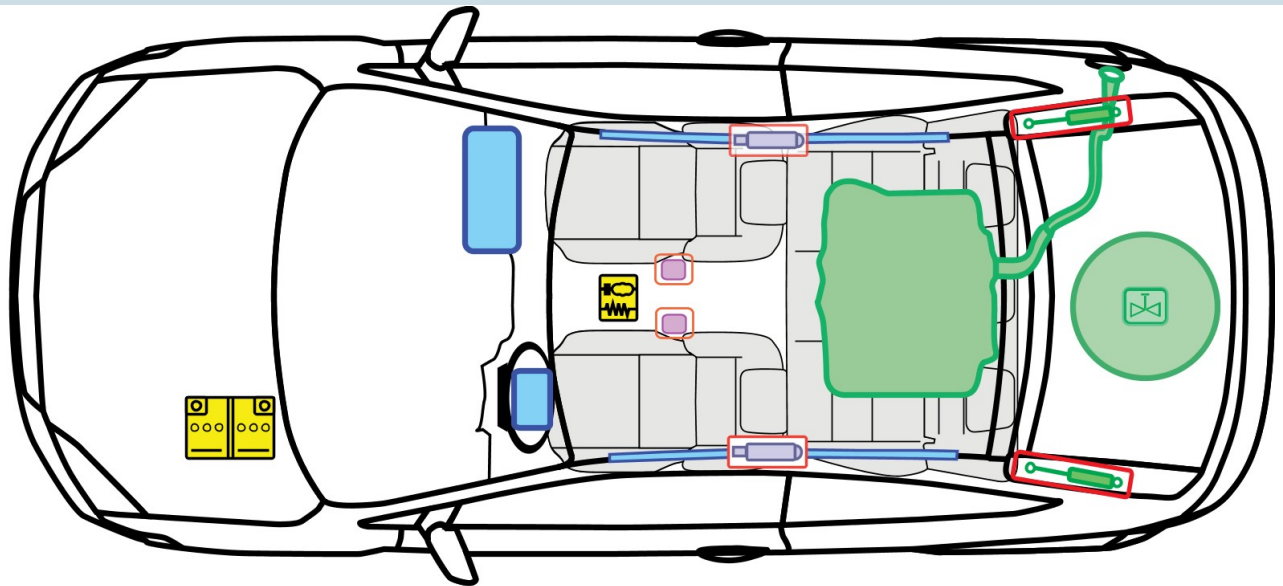

LPG

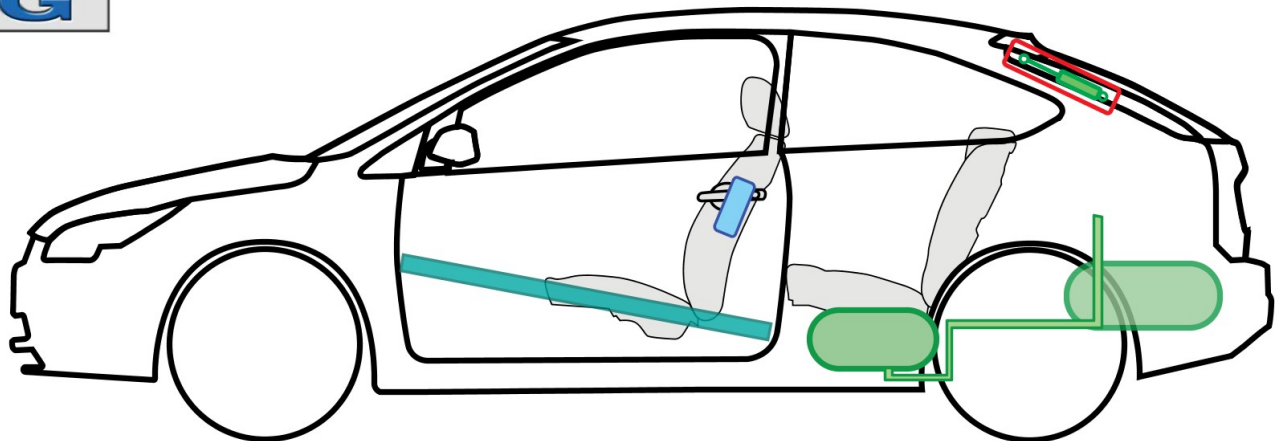

E137493

Legenda

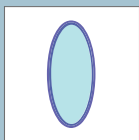

Ochronna poduszka powietrzna

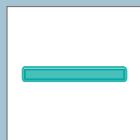

Wzmocnienia konstrukcji



Sterownik



Generator gazu



Aktywna ochrona w przypadku wywrócenia pojazdu
Sprężyna gazowa

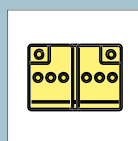

Akumulator



Zbiornika gazu

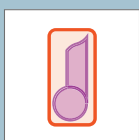

Napinaczy pasów

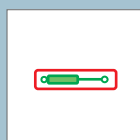

Zbiornik paliwa



Zawór bezpieczeństwa

FordFocus - LPG

Wersja 3-drzwiowa



E137212

07/2004 – 08/2007

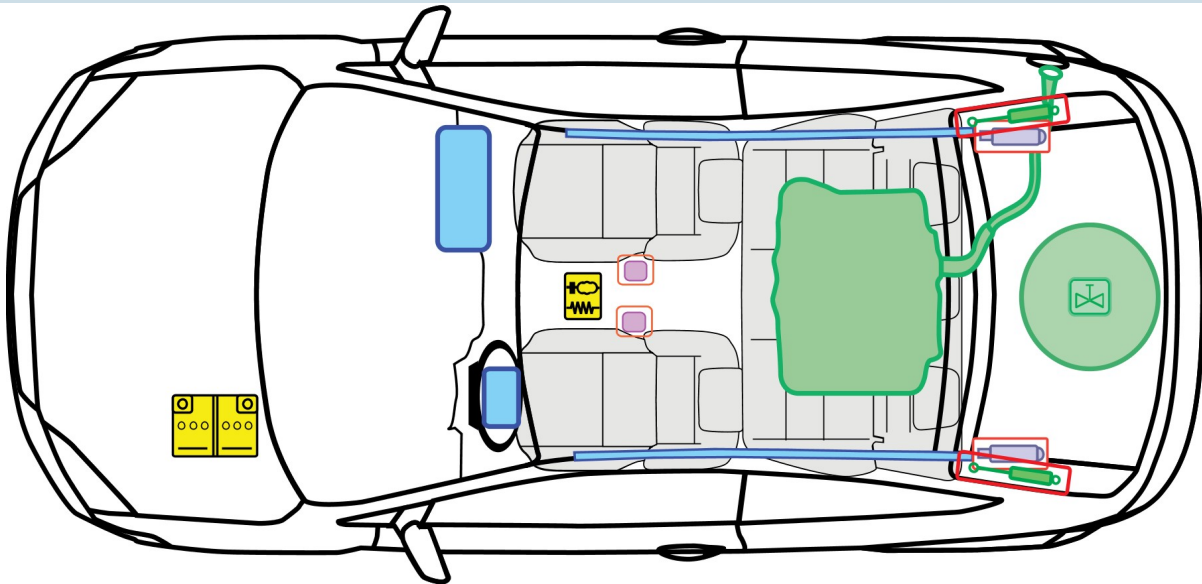

LPG

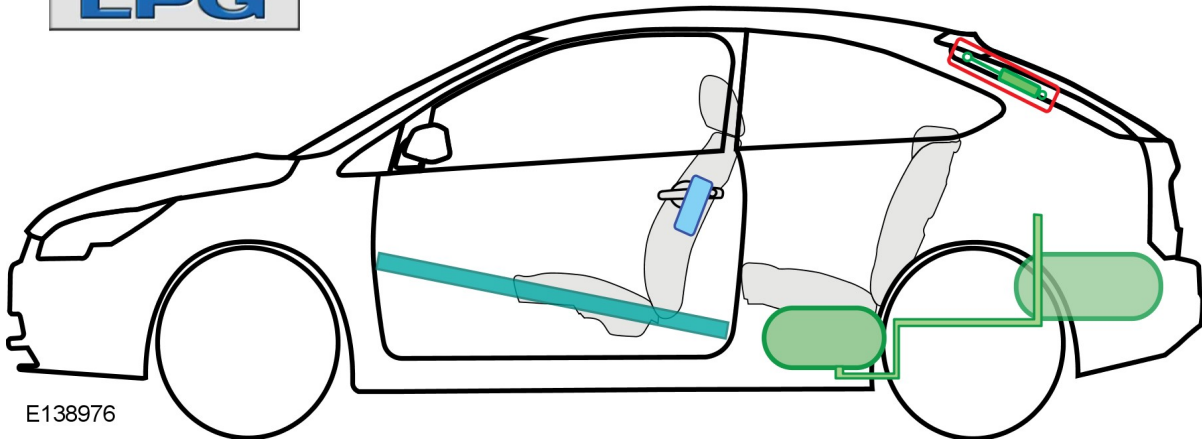

E138976

Legenda

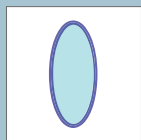

Ochronna poduszka powietrzna

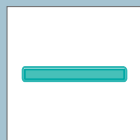

Wzmocnienia konstrukcji



Sterownik

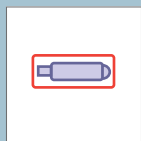

Generator gazu



Aktywna ochrona w przypadku wywrócenia pojazdu
Sprężyna gazowa

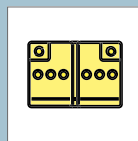

Akumulator



Zbiornika gazu

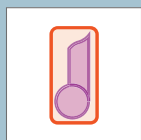

Napinaczy pasów

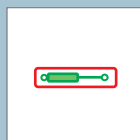

Zbiornik paliwa



Zawór bezpieczeństwa

FordFocus - CNG

Wersja 3-drzwiowa



E137238



07/2004 – 08/2007

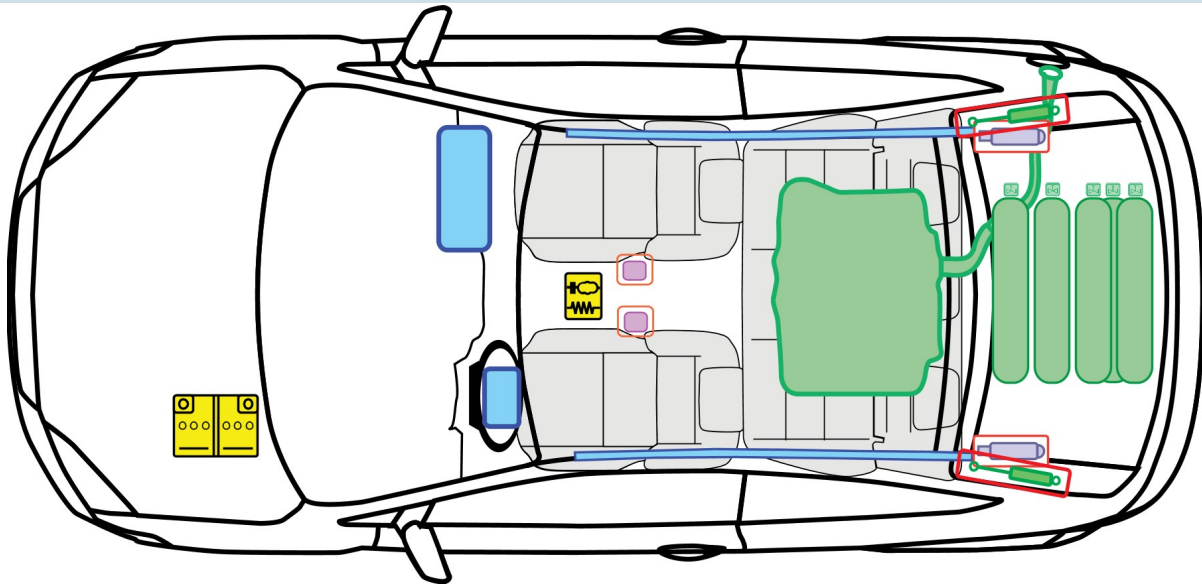

CNG

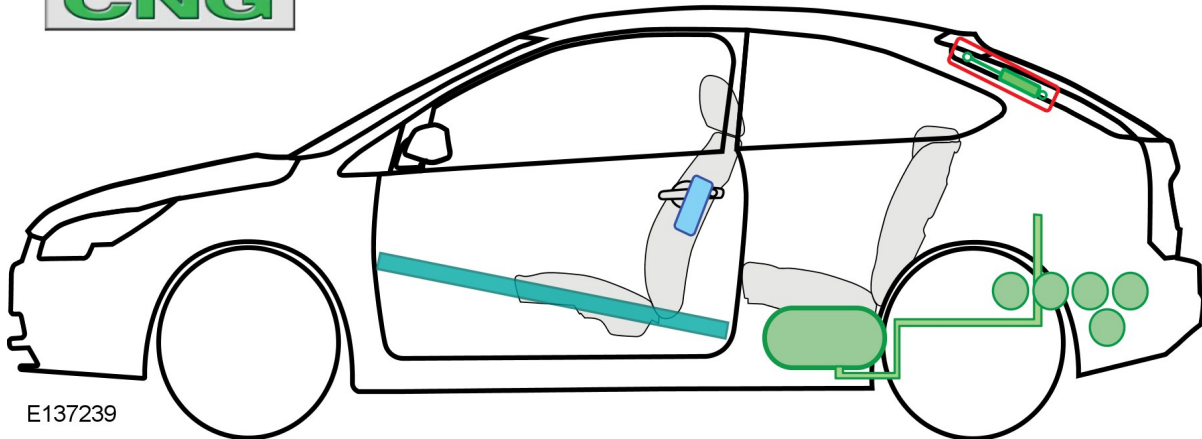

E137239

Legenda

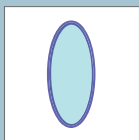

Ochronna poduszka powietrzna

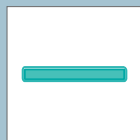

Wzmocnienia konstrukcji



Sterownik

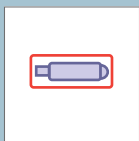

Generator gazu



Aktywna ochrona w przypadku wywrócenia pojazdu
Sprężyna gazowa

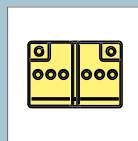

Akumulator



Zbiornika gazu

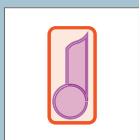

Napinaczy pasów

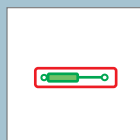

Zbiornik paliwa



Zawór bezpieczeństwa



Zawór bezpieczeństwa

FordFocus - CNG

Wersja 3-drzwiowa



E137224



08/2007 – 03/2011

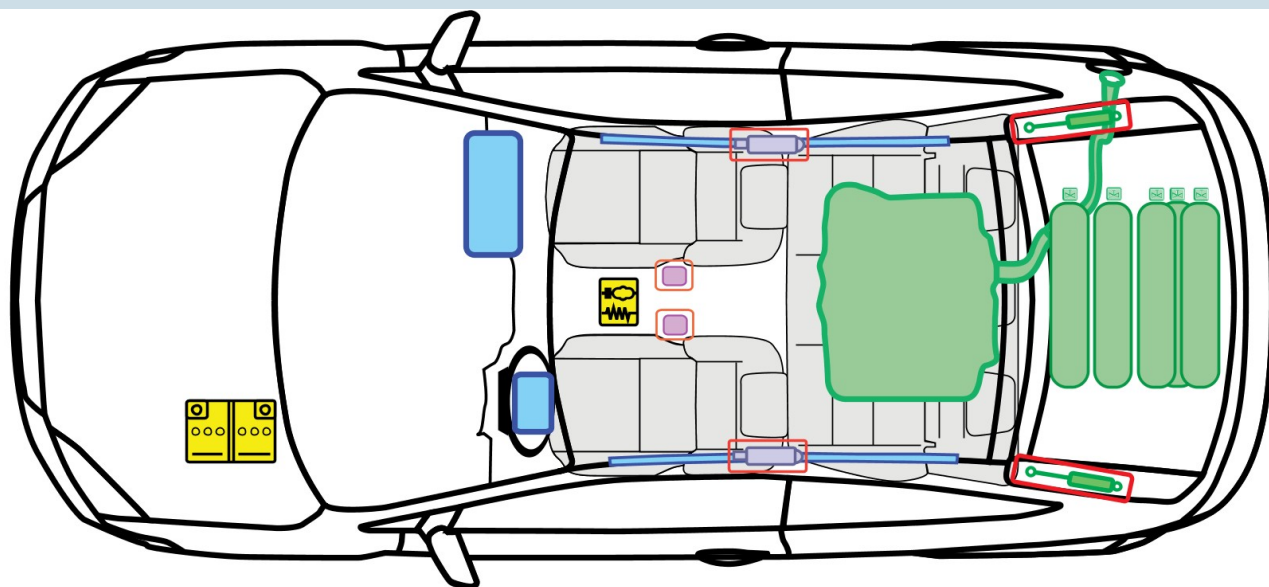

CNG

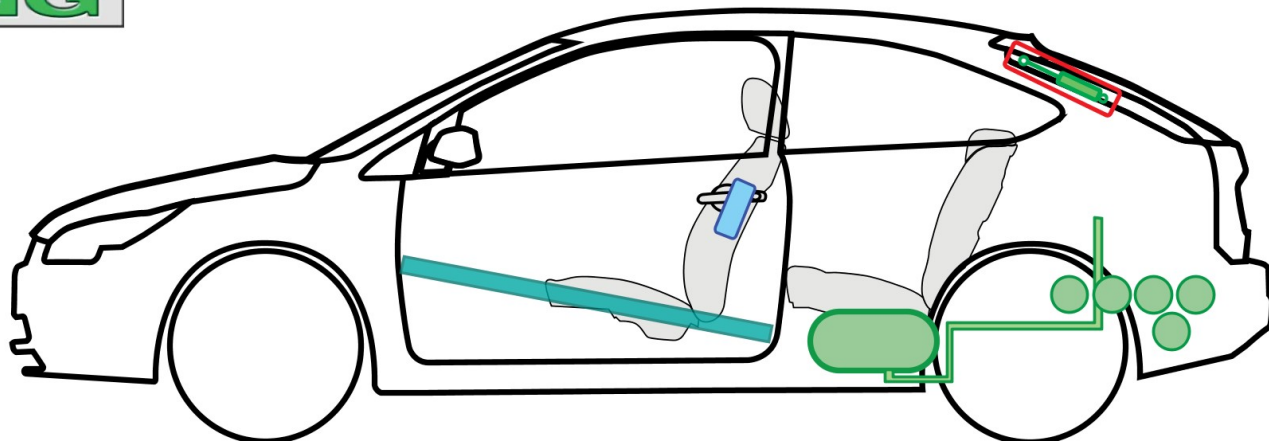

E137463

Legenda

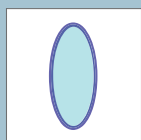

Ochronna poduszka powietrzna

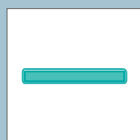

Wzmocnienia konstrukcji



Sterownik

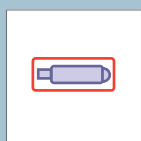

Generator gazu



Aktywna ochrona w przypadku wywrócenia pojazdu
Sprężyna gazowa

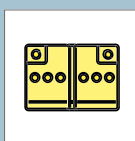

Akumulator



Zbiornika gazu

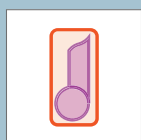

Napinaczy pasów

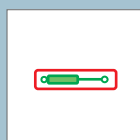

Sprężyna gazowa



Zbiornik paliwa



Zawór bezpieczeństwa

FordFocus

Wersja 4-drzwiowa



E137219



07/2004 – 08/2007

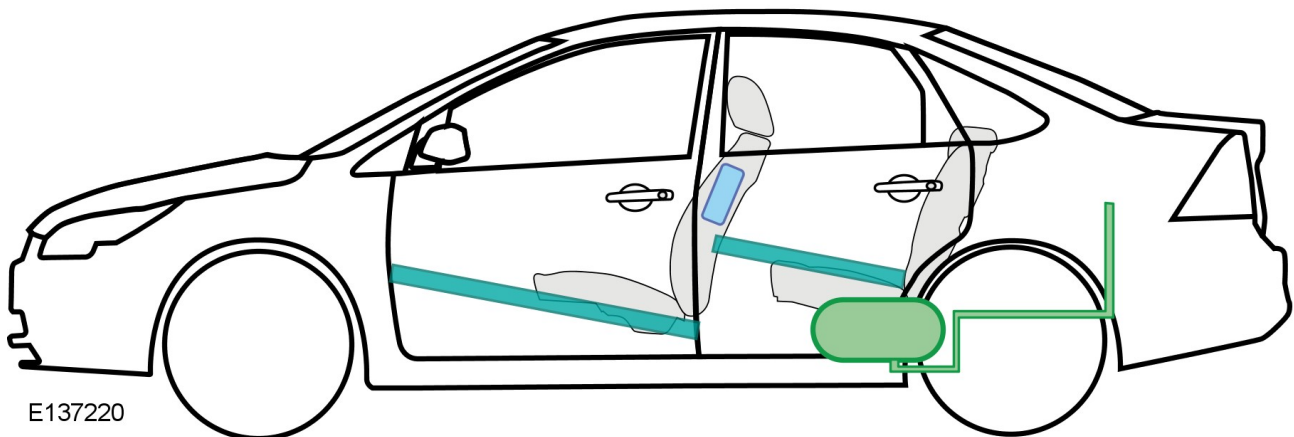
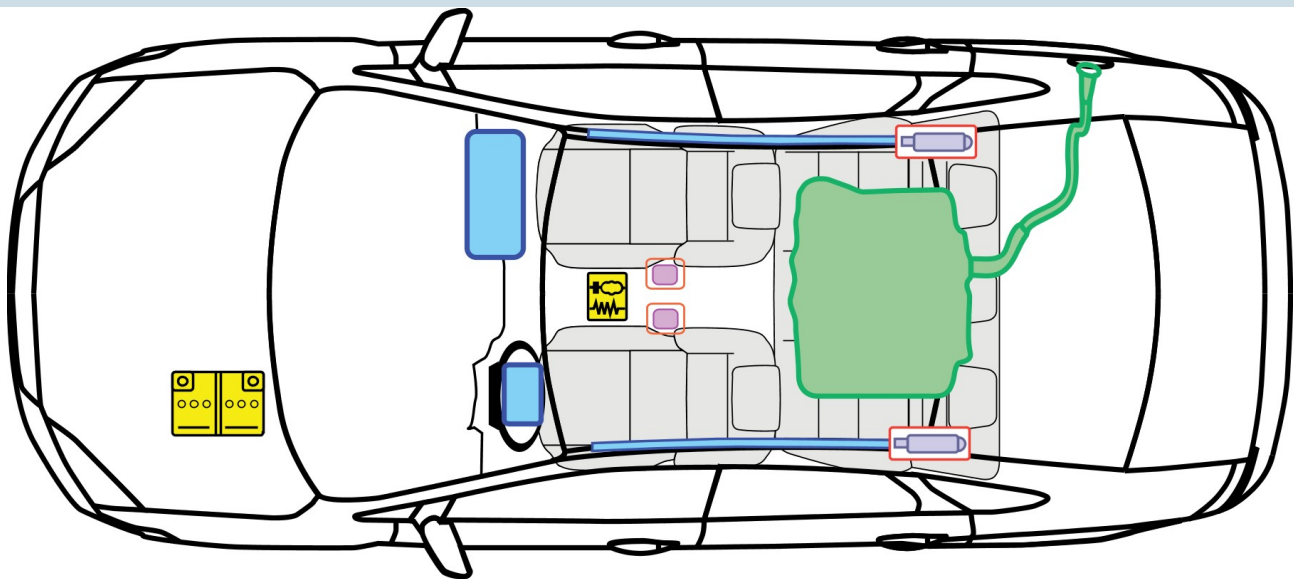

E137220

Legenda

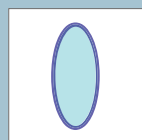

Ochronna poduszka powietrzna

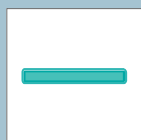

Wzmocnienia konstrukcji



Sterownik

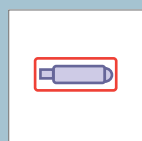

Generator gazu

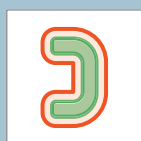

Aktywna ochrona w przypadku wywrócenia pojazdu
Sprężyna gazowa

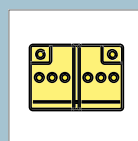

Akumulator

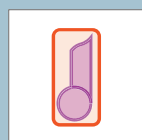

Napinaczy pasów



Zbiornik paliwa

F



FordFocus

Wersja 4-drzwiowa

E138516





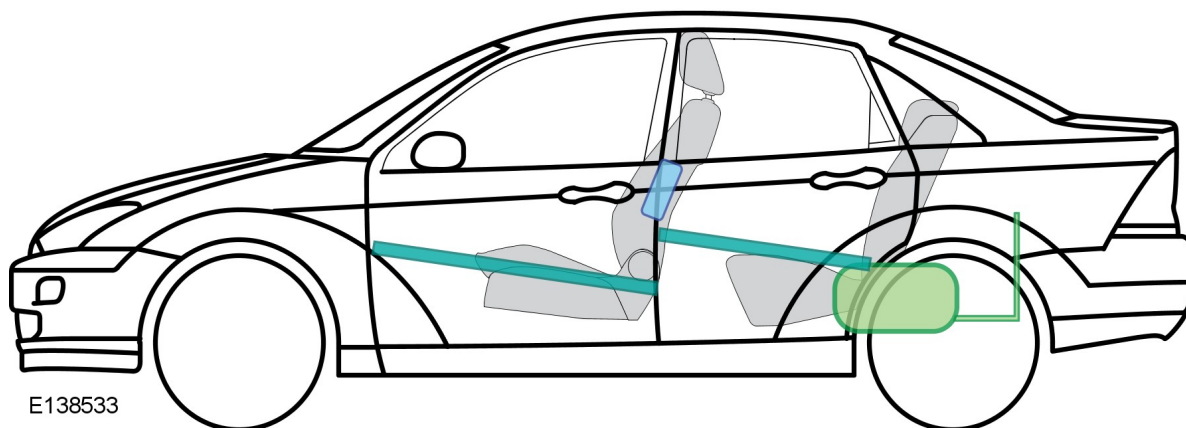
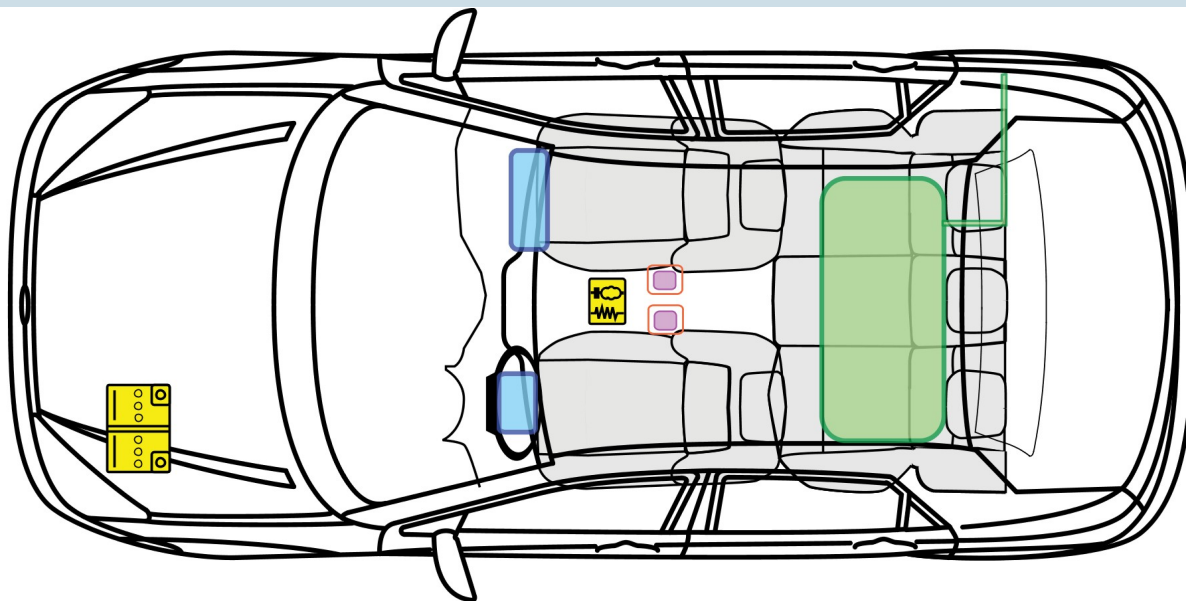



08/1998 – 12/2004

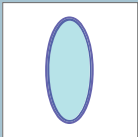

E138533

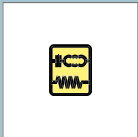
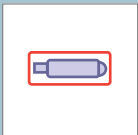
Legenda

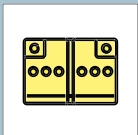
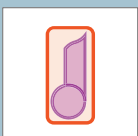
F

	Ochronna poduszka powietrzna		Wzmocnienia konstrukcji		Sterownik
	Generator gazu		Aktywna ochrona w przypadku wywrócenia pojazdu		Akumulator
	Napinaczy pasów		Sprężyna gazowa		Zbiornik paliwa

FordFocus

Wersja 4-drzwiowa



E137219



08/2007 – 03/2011

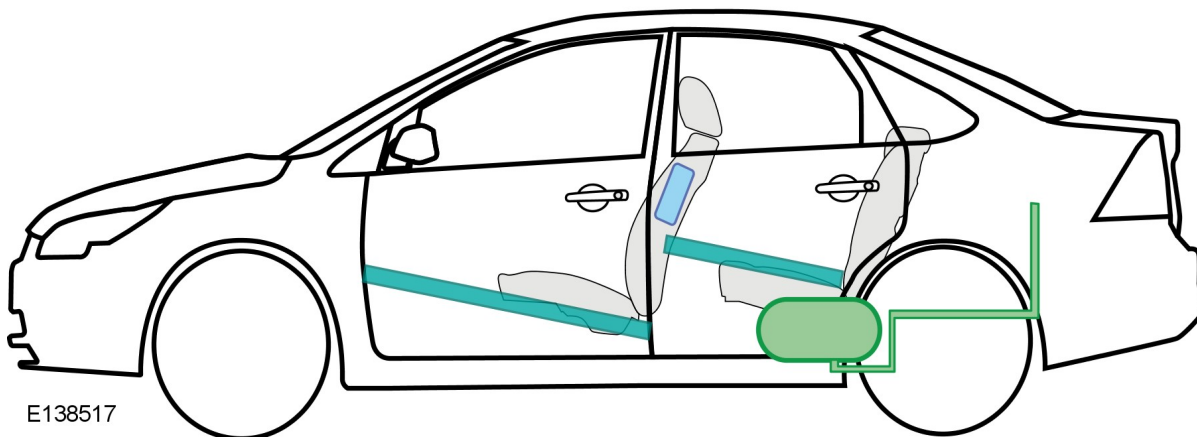
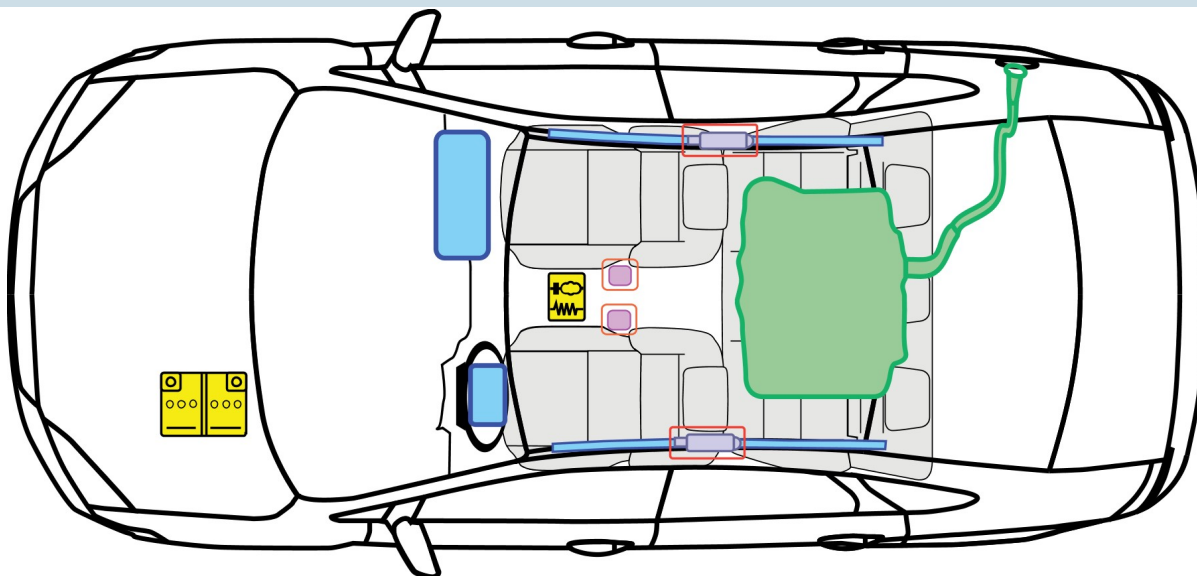

E138517

Legenda

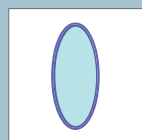

Ochronna poduszka powietrzna

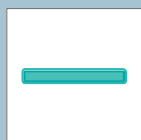

Wzmocnienia konstrukcji



Sterownik

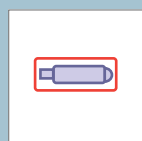

Generator gazu

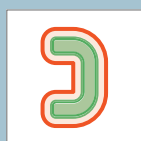

Aktywna ochrona w przypadku wywrócenia pojazdu
Sprężyna gazowa

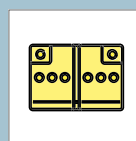

Akumulator

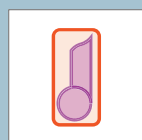

Napinaczy pasów

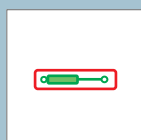

Zbiornik paliwa

FordFocus

Wersja 4-drzwiowa



E139167

03/2011 – >

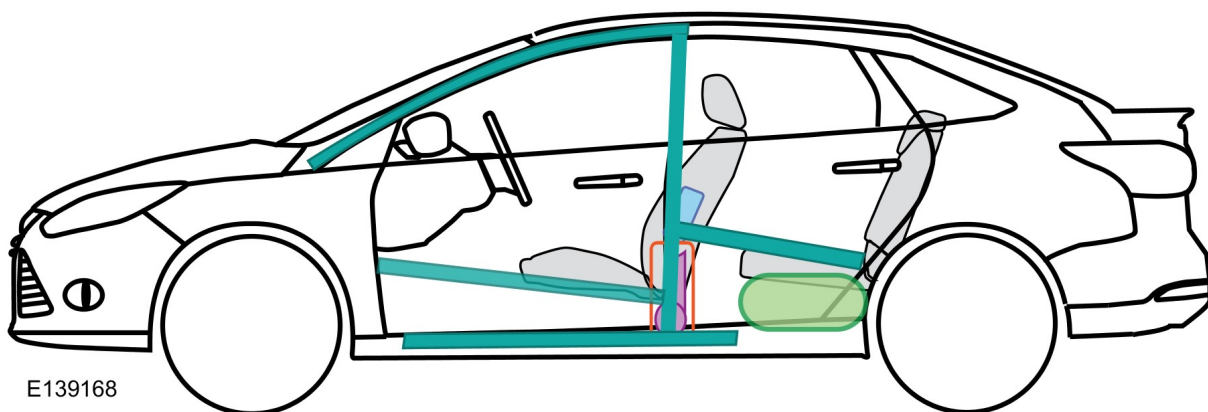
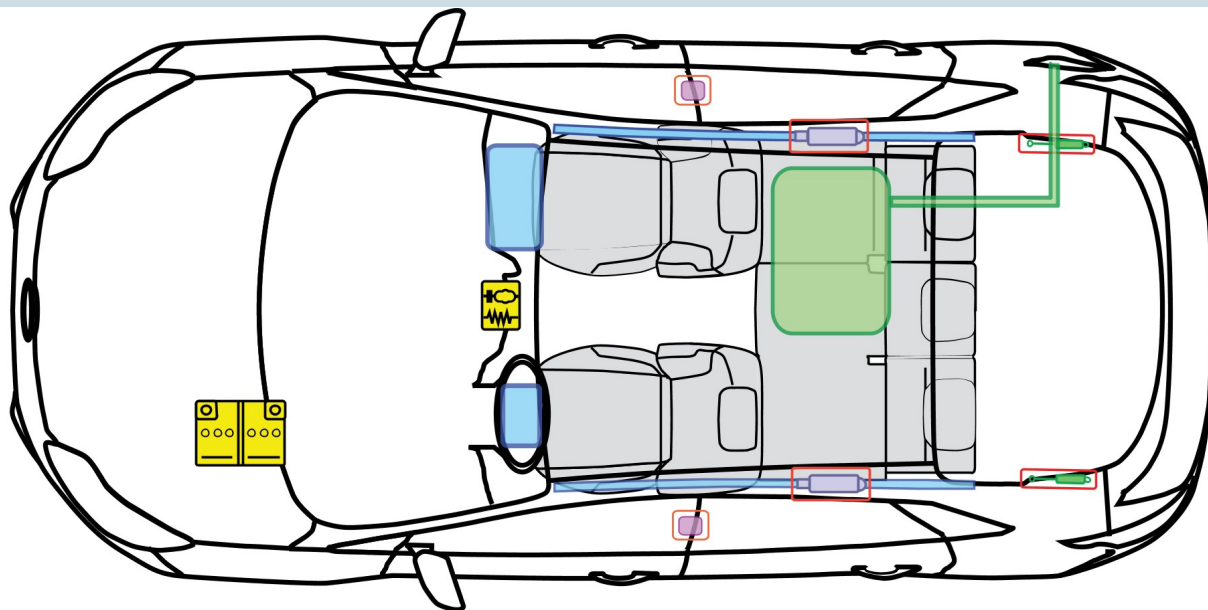

E139168

Legenda

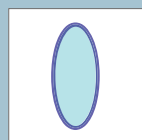

Ochronna poduszka powietrzna

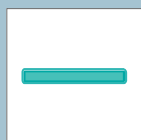

Wzmocnienia konstrukcji



Sterownik

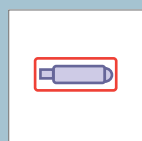

Generator gazu

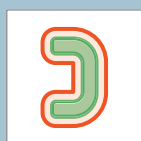

Aktywna ochrona w przypadku wywrócenia pojazdu

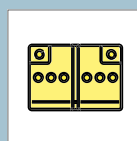

Akumulator

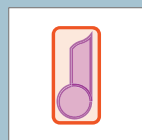

Napinacze pasów

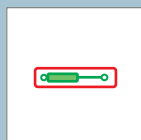

Sprężyna gazowa



Zbiornik paliwa



Ford Focus

Wersja 5-drzwiowa



E137240

08/2007 – 03/2011

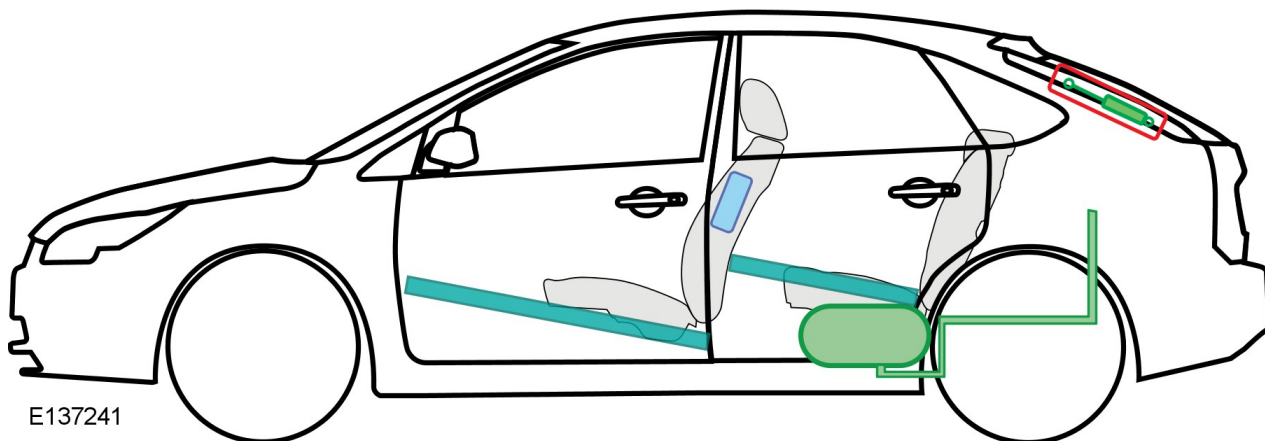
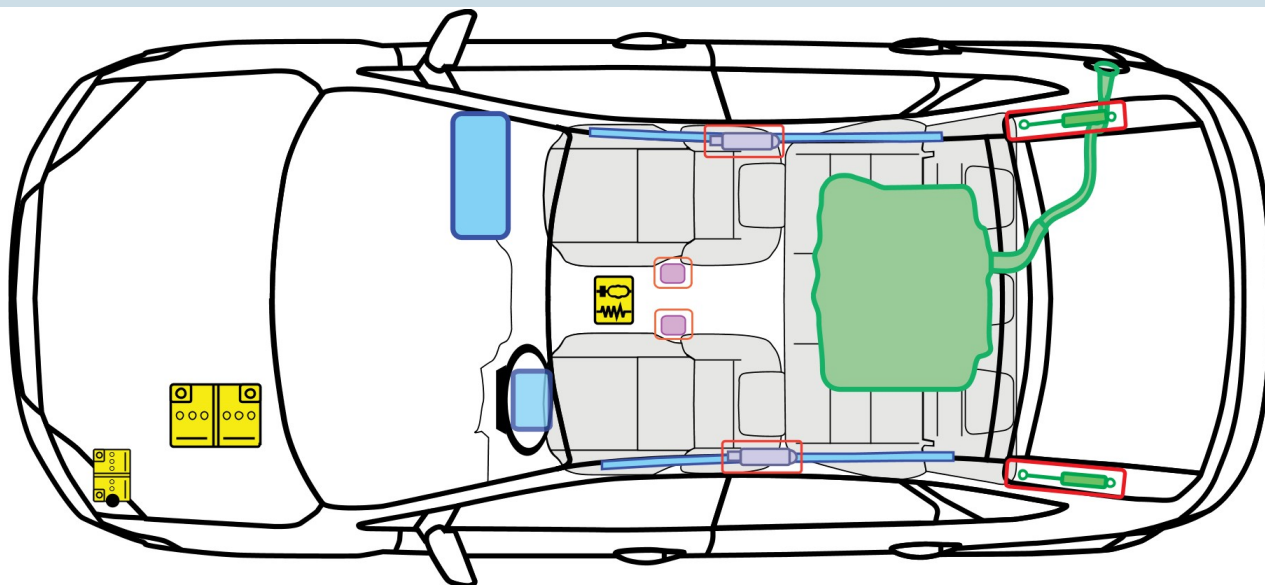

E137241

Legenda

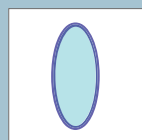

Ochronna poduszka powietrzna

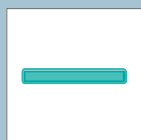

Wzmocnienia konstrukcji



Sterownik

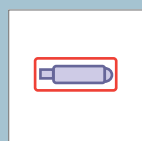

Generator gazu

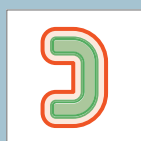

Aktywna ochrona w przypadku wywrócenia pojazdu
Sprężyna gazowa

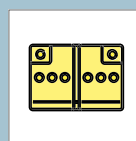

Akumulator

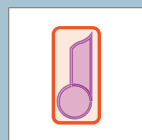

Napinacze pasów

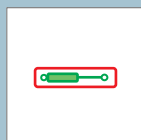

Zbiornik paliwa

F

Ford Focus

Wersja 5-drzwiowa

E137995



08/1998 – 12/2004

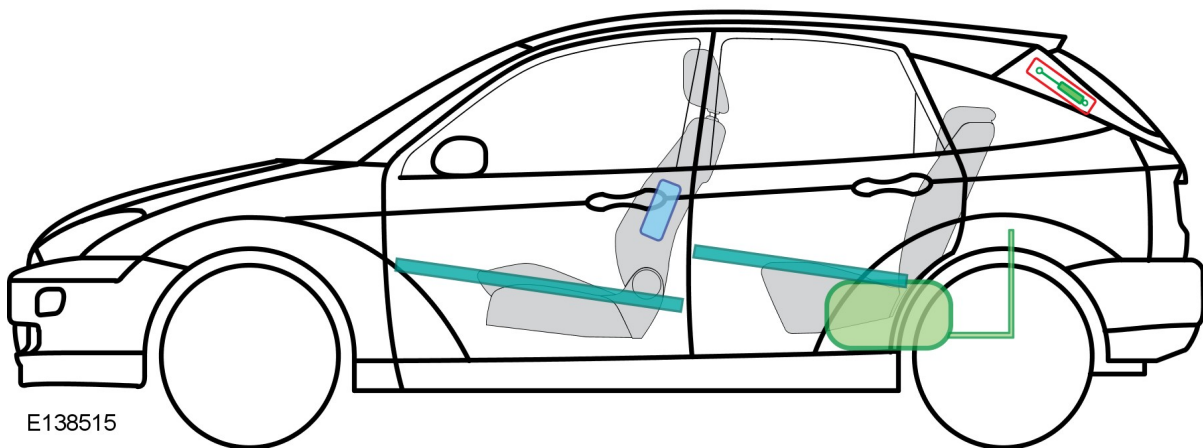
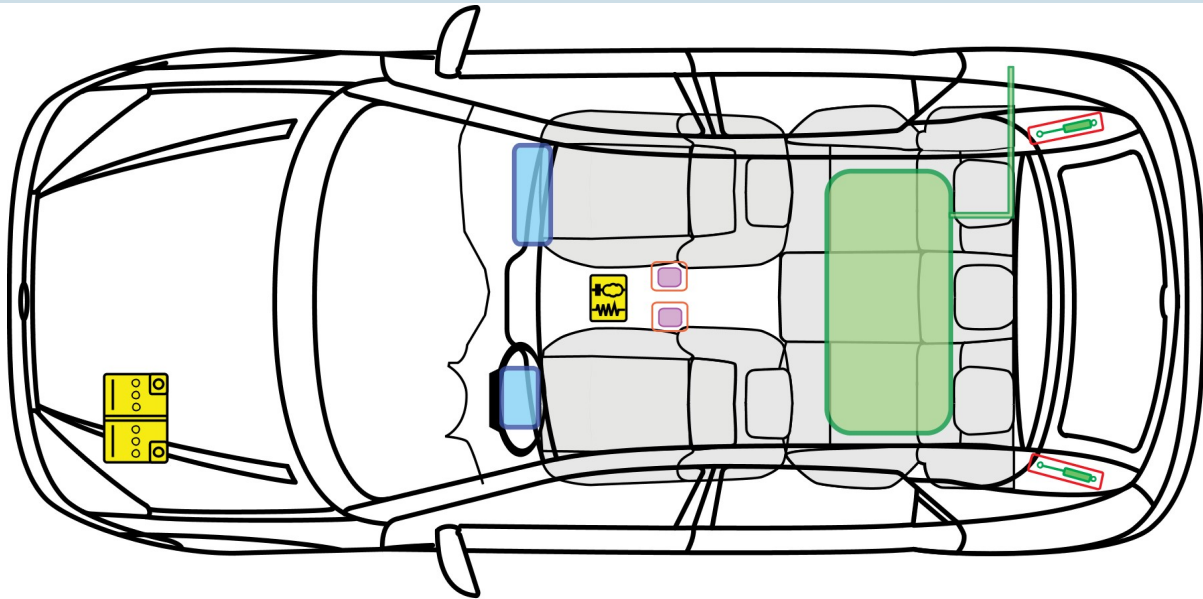

E138515

Legenda

F

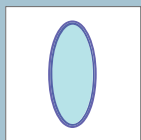

Ochronna poduszka powietrzna

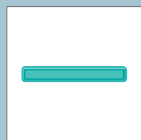

Wzmocnienia konstrukcji



Sterownik

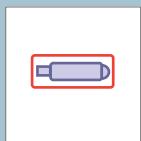

Generator gazu



Aktywna ochrona w przypadku wywrócenia pojazdu
Sprężyna gazowa

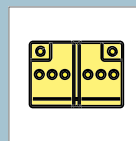

Akumulator

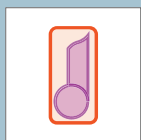

Napinacze pasów

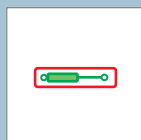

Zbiornik paliwa

FordFocus

Wersja 5-drzwiowa

E139059



03/2011 – >

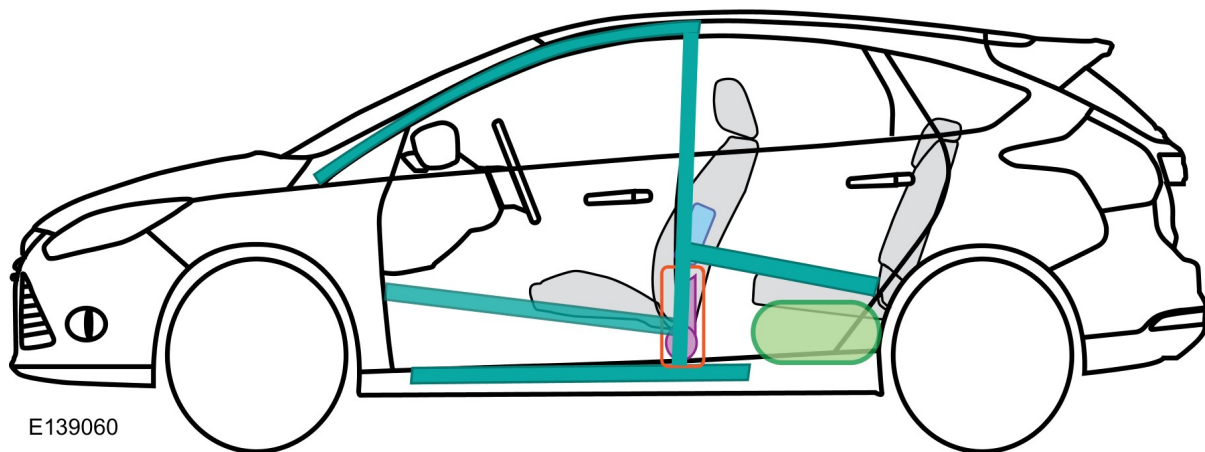
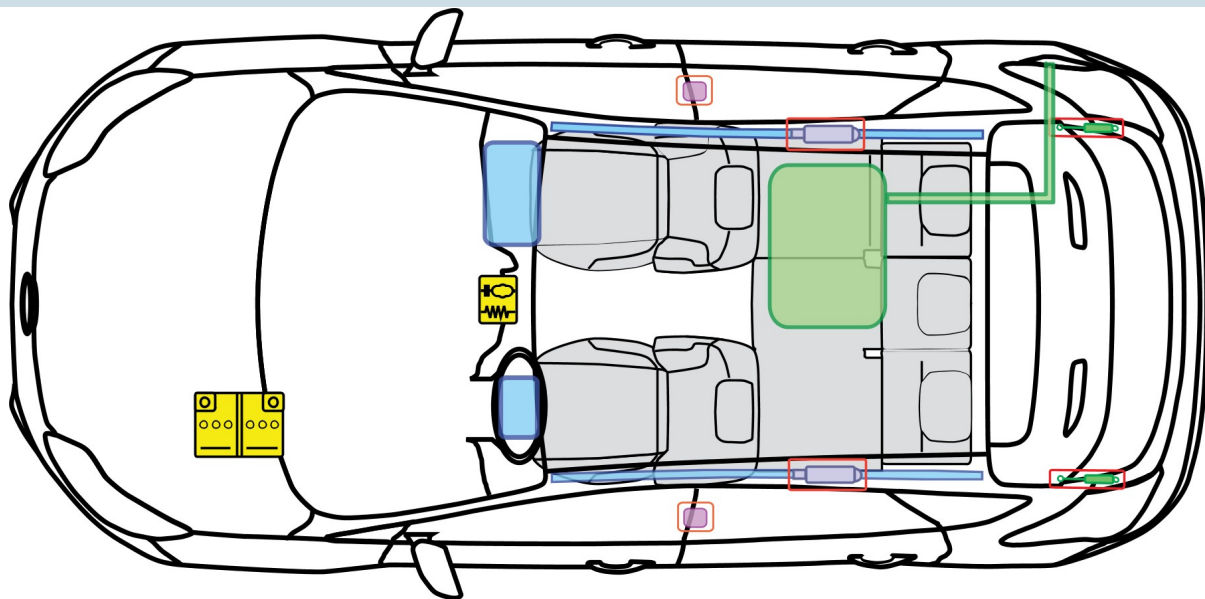

E139060

Legenda

F

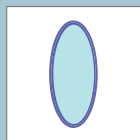

Ochronna poduszka powietrzna

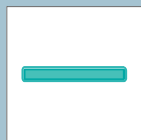

Wzmocnienia konstrukcji



Sterownik

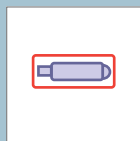

Generator gazu



Aktywna ochrona w przypadku wywrócenia pojazdu
Sprężyna gazowa

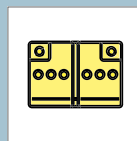

Akumulator

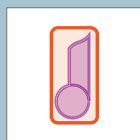

Napinaczy pasów

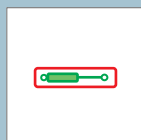

Zbiornik paliwa

FordFocus

Wersja 5-drzwiowa



E137240



07/2004 – 08/2007

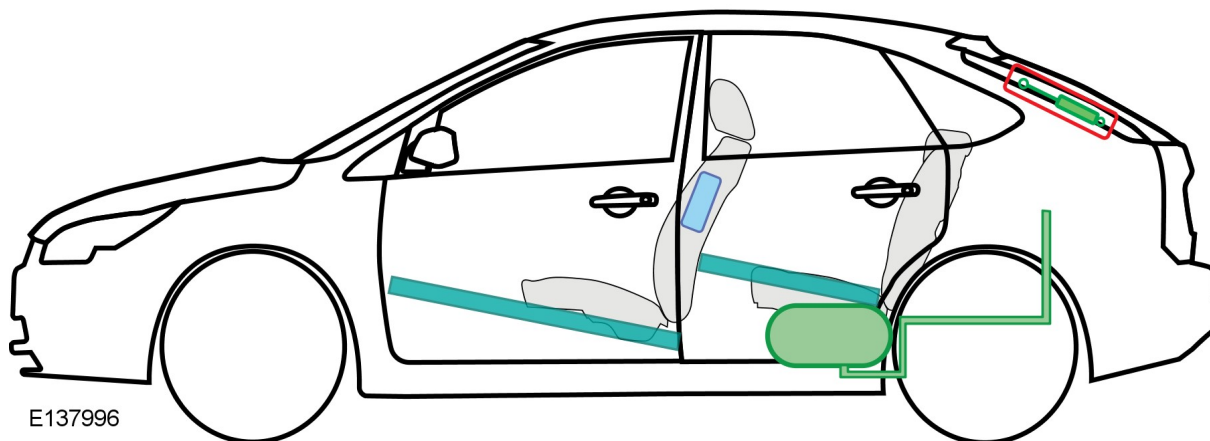
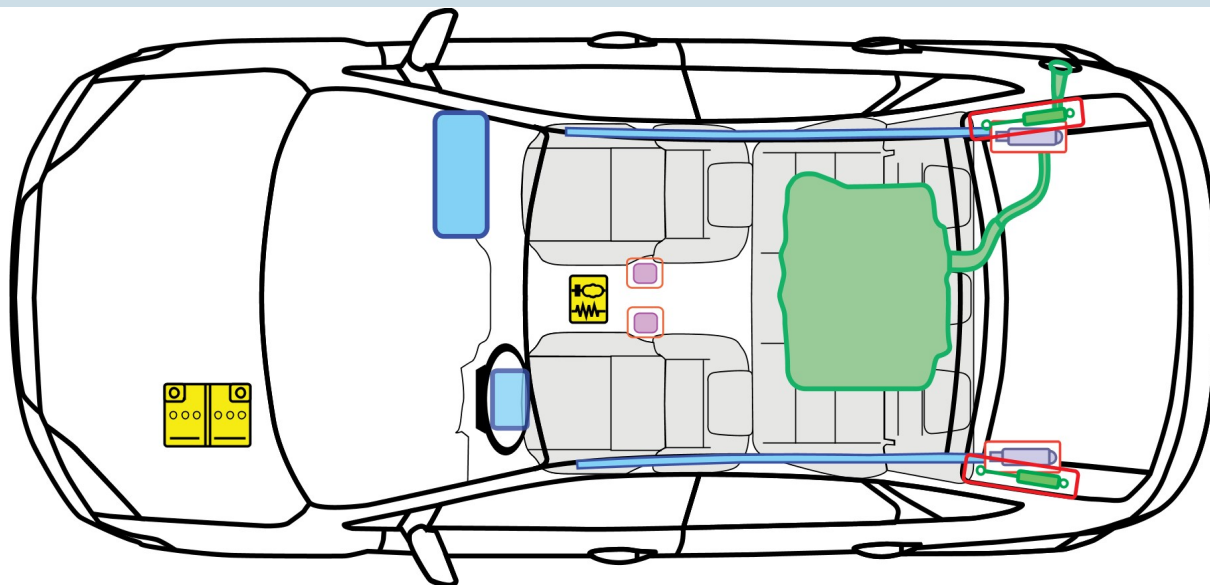

E137996

Legenda

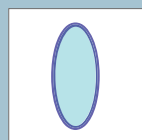

Ochronna poduszka powietrzna

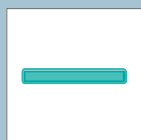

Wzmocnienia konstrukcji



Sterownik

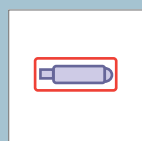

Generator gazu

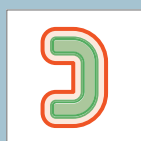

Aktywna ochrona w przypadku wywrócenia pojazdu
Sprężyna gazowa

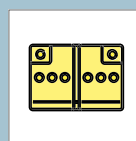

Akumulator

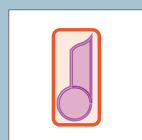

Napinacze pasów

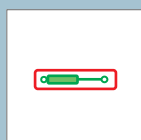

Zbiornik paliwa

F

Ford Focus - LPG

Wersja 5-drzwiowa



E137240



08/2007 – 03/2011

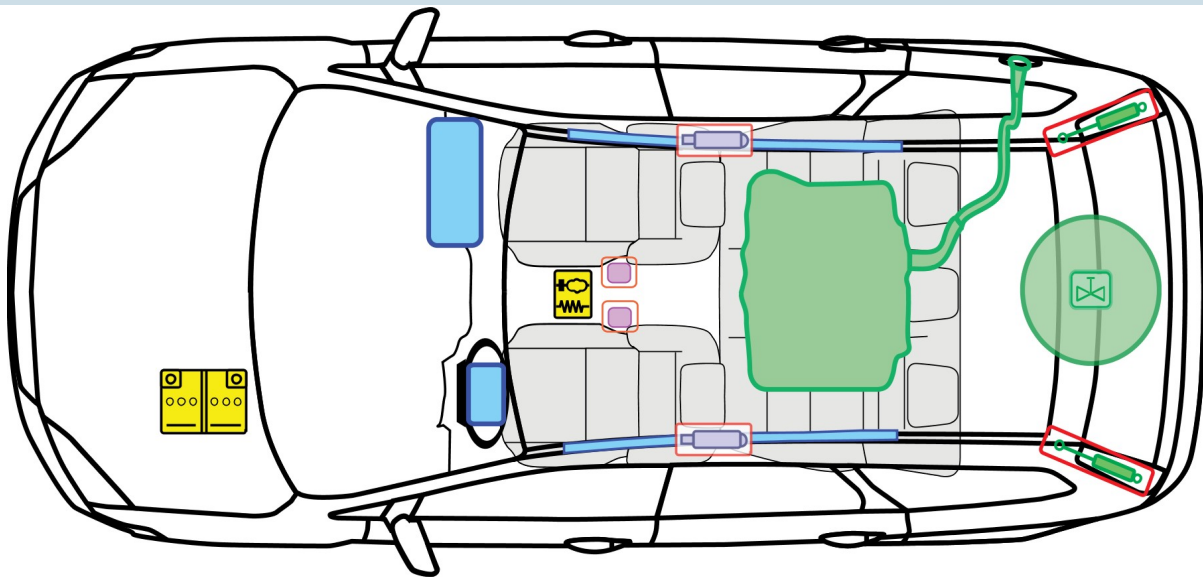

LPG

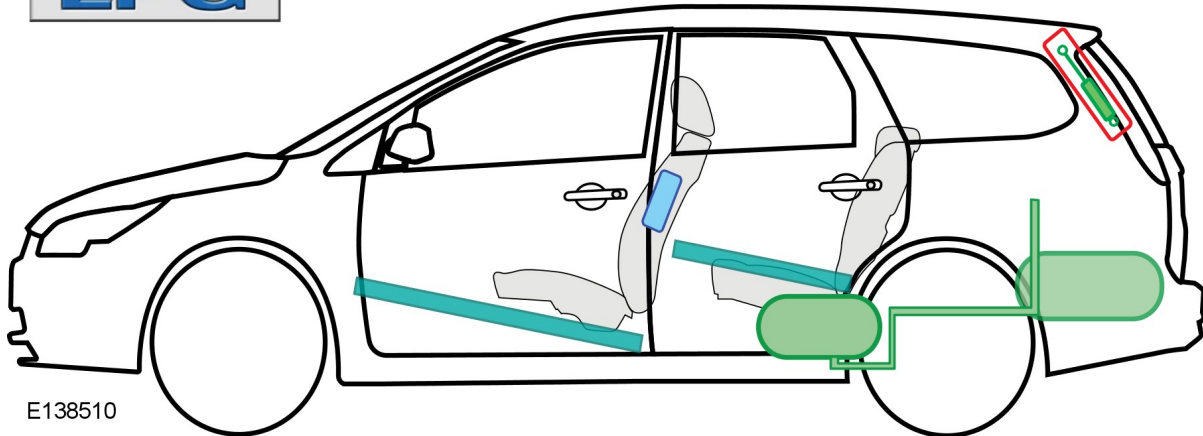

E138510

Legenda

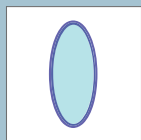

Ochronna poduszka powietrzna

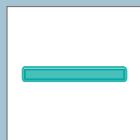

Wzmocnienia konstrukcji



Sterownik

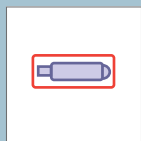

Generator gazu



Aktywna ochrona w przypadku wywrócenia pojazdu
Sprężyna gazowa

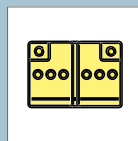

Akumulator



Zbiornika gazu

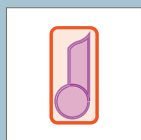

Napinaczy pasów

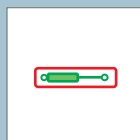

Zbiornik paliwa



Zawór bezpieczeństwa

Ford Focus - LPG

Wersja 5-drzwiowa



E137240



07/2004 – 08/2007

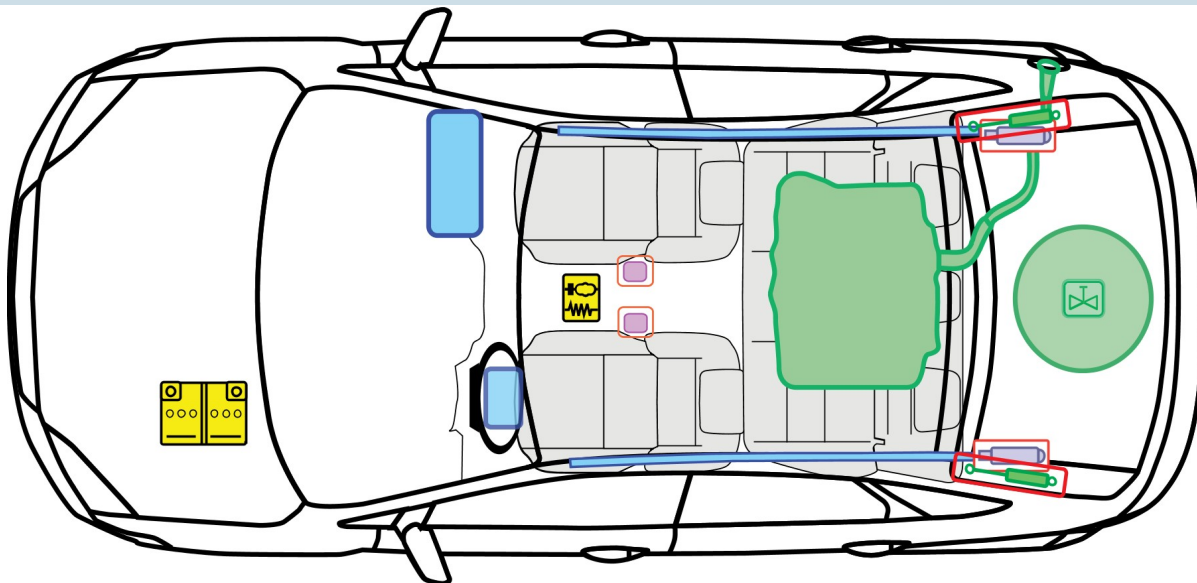

LPG

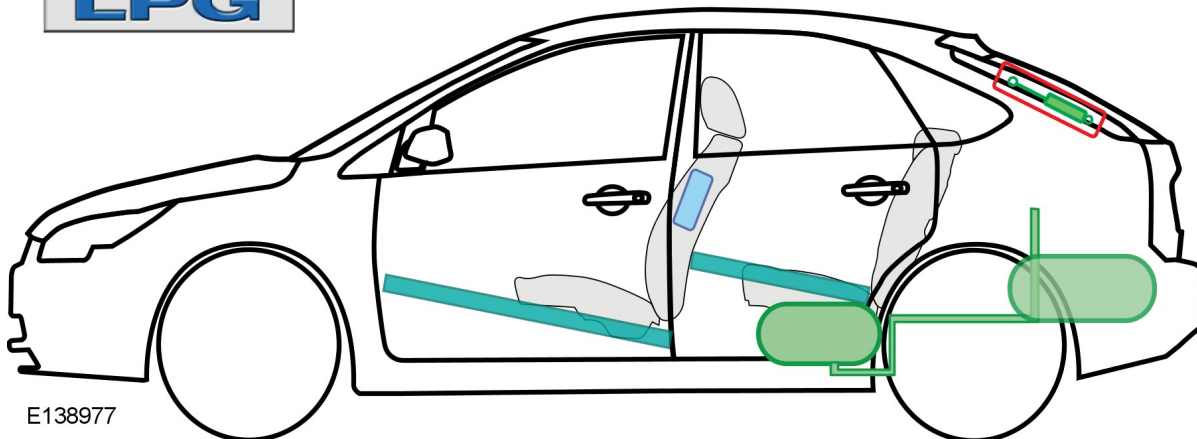

E138977

Legenda

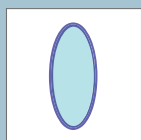

Ochronna poduszka powietrzna

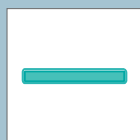

Wzmocnienia konstrukcji



Sterownik

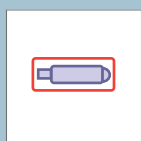

Generator gazu



Aktywna ochrona w przypadku wywrócenia pojazdu
Sprężyna gazowa

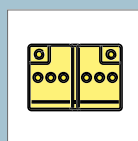

Akumulator



Zbiornika gazu

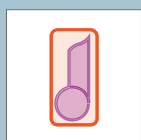

Napinaczy pasów

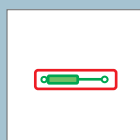

Zbiornik paliwa



Zawór bezpieczeństwa



Zawór bezpieczeństwa

Ford Focus - LPG

Wersja 5-drzwiowa

E139059



05/2012 – >

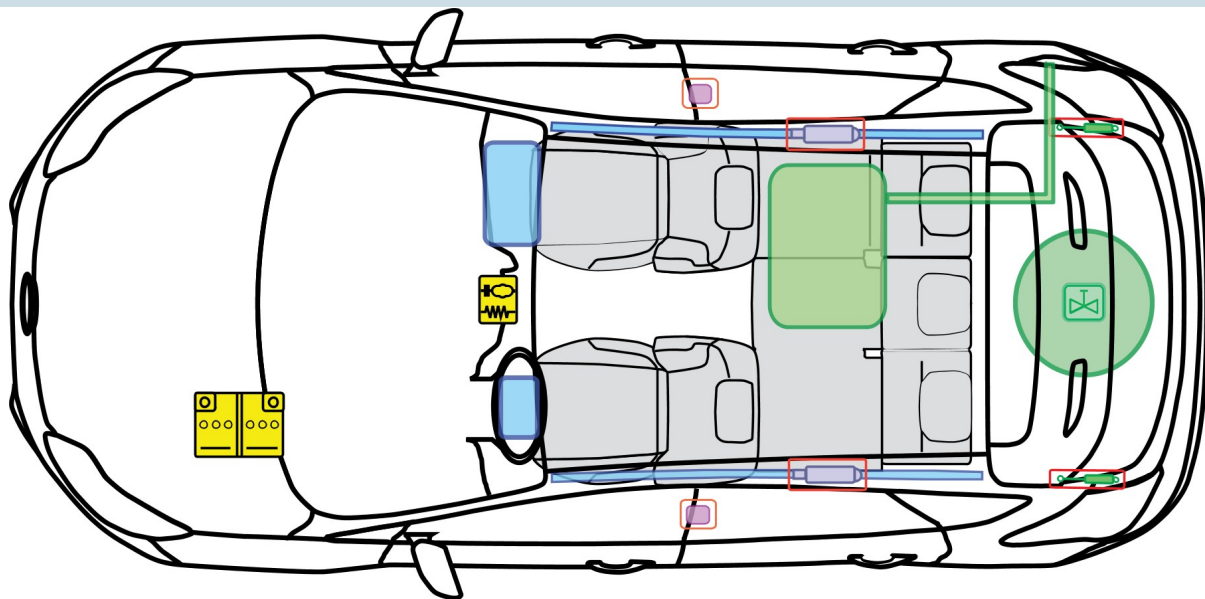

LPG

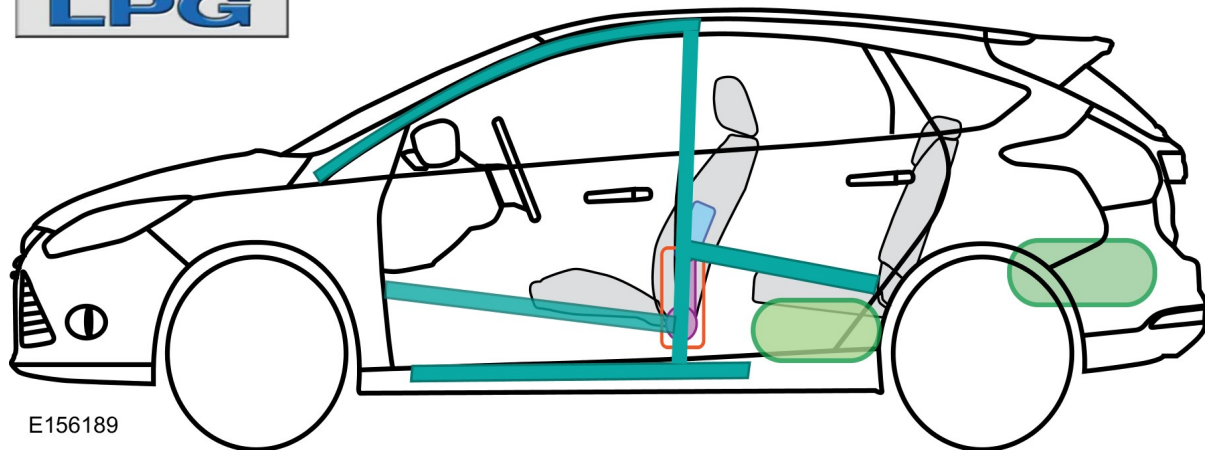

E156189

Legenda

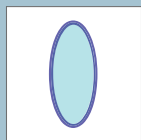

Ochronna poduszka powietrzna

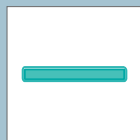

Wzmocnienia konstrukcji



Sterownik

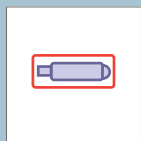

Generator gazu



Aktywna ochrona w przypadku wywrócenia pojazdu
Sprężyna gazowa

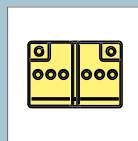

Akumulator



Zbiornika gazu

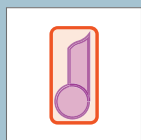

Napinacze pasów

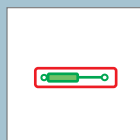

Sprężyna gazowa



Zbiornik paliwa



Zawór bezpieczeństwa

Ford Focus - CNG

Wersja 5-drzwiowa



E137240

08/2007 – 03/2011

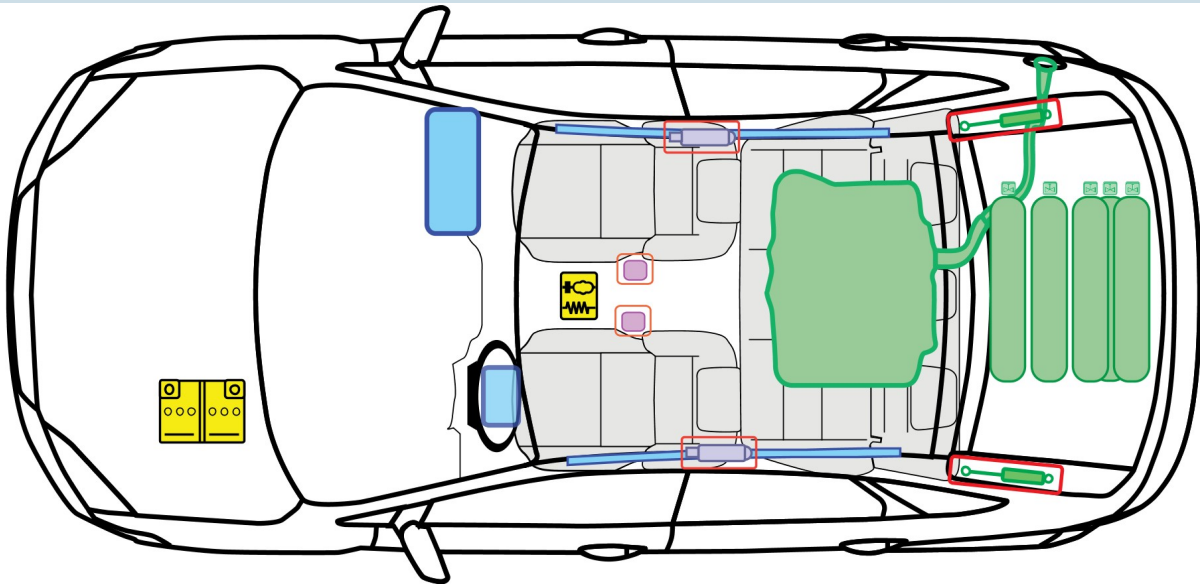

CNG

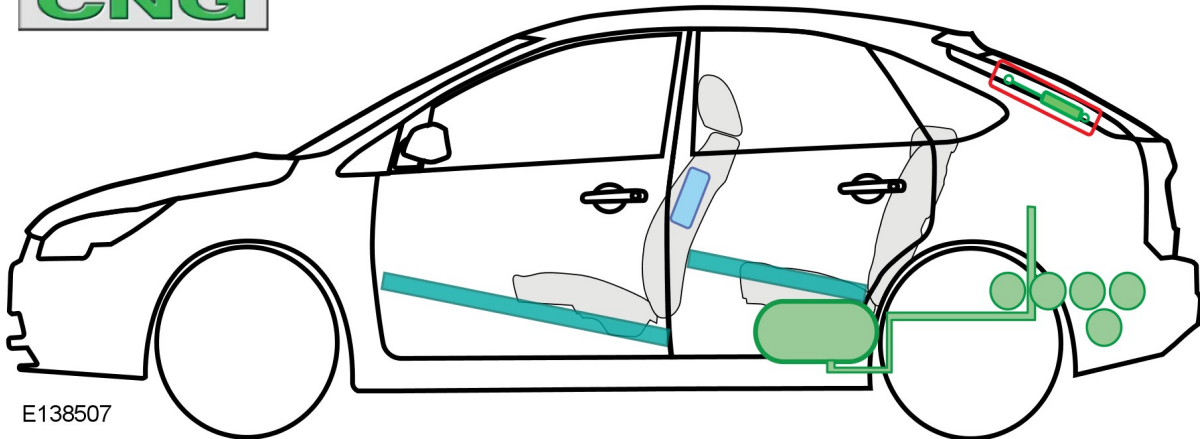

E138507

Legenda

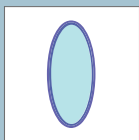

Ochronna poduszka powietrzna

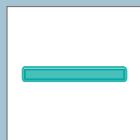

Wzmocnienia konstrukcji



Sterownik

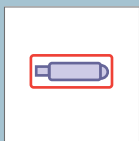

Generator gazu



Aktywna ochrona w przypadku wywrócenia pojazdu
Sprężyna gazowa

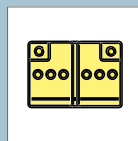

Akumulator



Zbiornika gazu

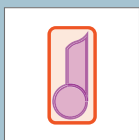

Napinaczy pasów

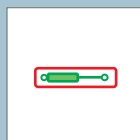

Zbiornik paliwa



Zawór bezpieczeństwa

Ford Focus - CNG

Wersja 5-drzwiowa



E137240

07/2004 – 08/2007

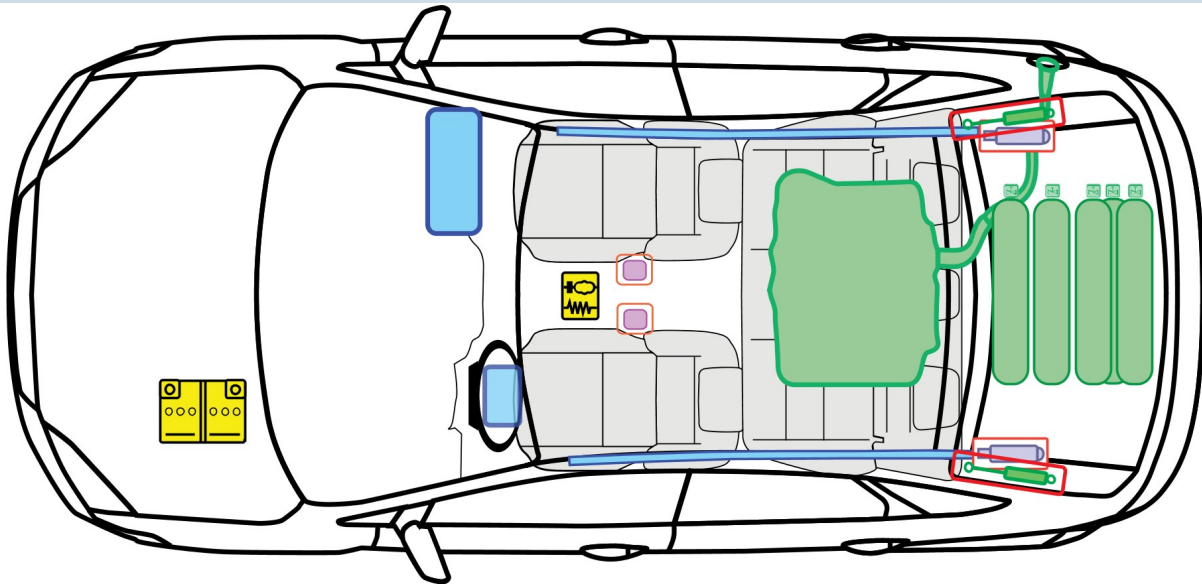

CNG

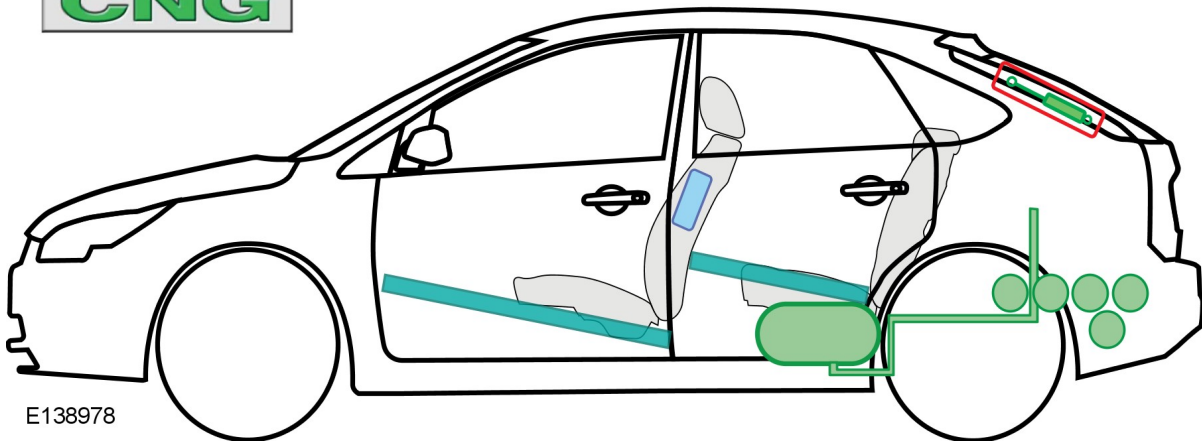

E138978

Legenda

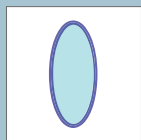

Ochronna poduszka powietrzna

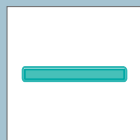

Wzmocnienia konstrukcji



Sterownik

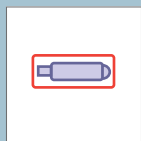

Generator gazu



Aktywna ochrona w przypadku wywrócenia pojazdu
Sprężyna gazowa

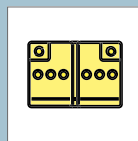

Akumulator



Zbiornika gazu

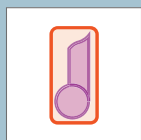

Napinaczy pasów

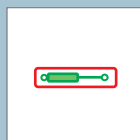

Zbiornik paliwa



Zawór bezpieczeństwa

Ford Focus E=LECTRIC



E171187

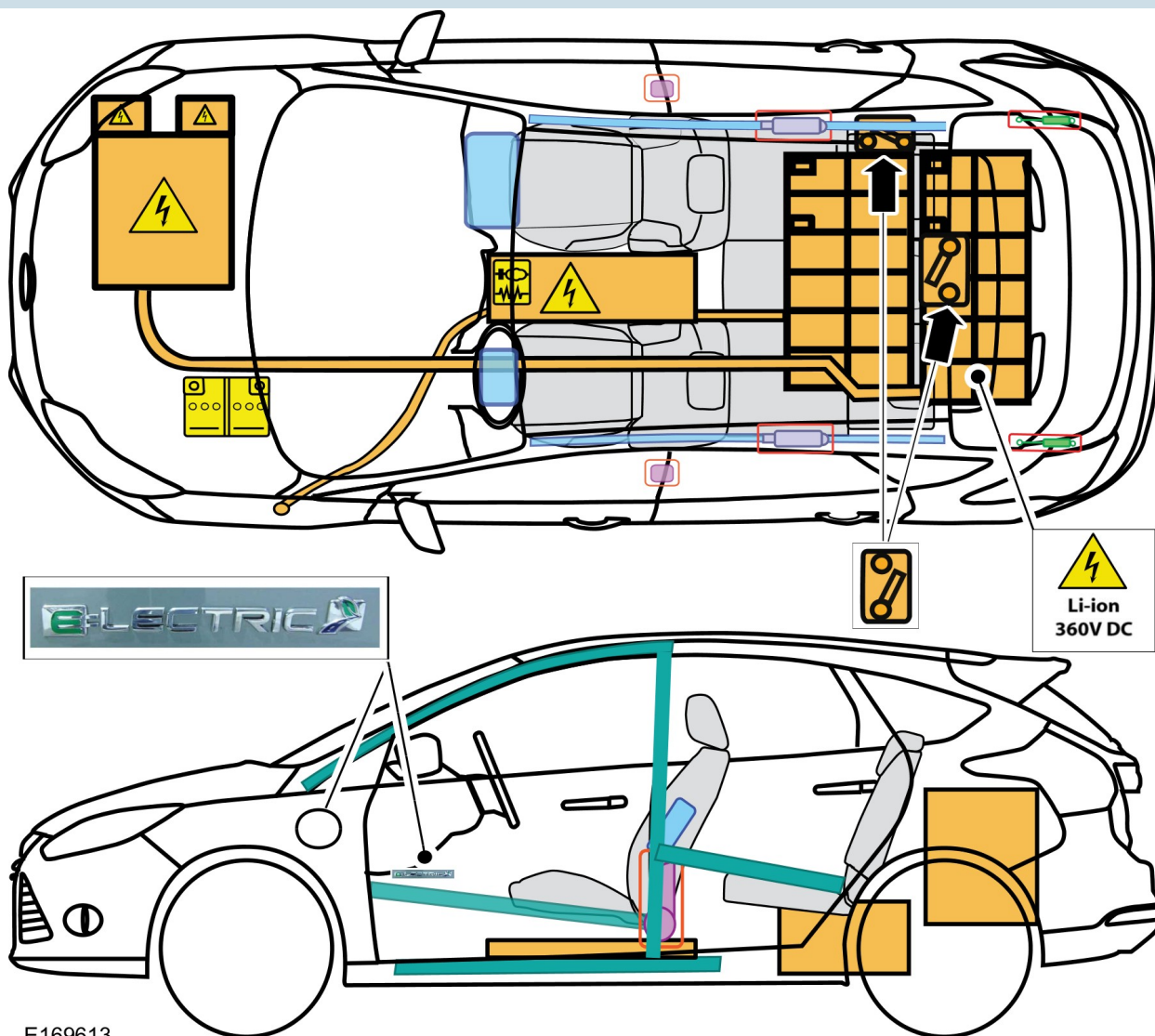

E169613

Legenda

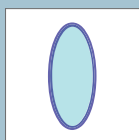

Ochronna poduszka powietrzna

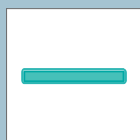

Wzmocnienia konstrukcji



Sterownik

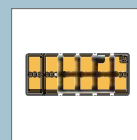

Akumulator wysokonapięciowy

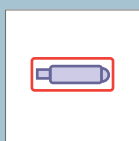

Generator gazu

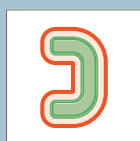

Aktywna ochrona w przypadku wywrócenia pojazdu
Sprężyna gazowa



Elementy pod wysokim napięciem

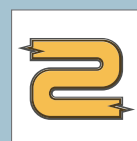

Przewód / elementy pod wysokim napięciem

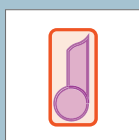

Napinaczy pasów

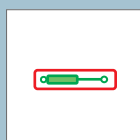

Sprężyna gazowa



Czujnik mechaniczny



Punkt odłączania wysokiego napięcia

Wyłączenie UKŁADU WYSOKIEGO NAPIĘCIA

Wstęp

NALEŻY ZAWSZE ZAKŁADAĆ, ŻE UKŁAD WYSOKIEGO NAPIĘCIA W POJEŹDZIE JEST PODŁĄCZONY DO ZASILANIA!

PRZED WEJŚCIEM DO POJAZDU DOPILNUJ, BY ODŁĄCZONO WSZELKIE ZEWNĘTRZNE ŹRÓDŁA ZASILANIA (np. ładowarka elektryczna, narzędzia elektryczne). Niezastosowanie się do tych zaleceń może spowodować poważne obrażenia ciała lub śmierć.

IDENTYFIKACJA POJAZDU Z NAPĘDEM ELEKTRYCZNYM

Identyfikacja na podstawie cech pojazdu



1. Tabliczka „E=LECTRIC” na obu skrzydłach drzwi przednich oraz na drzwiach tyłu nadwozia
2. Port ładowania akumulatora WYSOKONAPIĘCIOWEGO (zintegrowany z przednim błotnikiem z lewej strony)
3. Brak układu wydechowego
4. Brak pokrywy wlewu paliwa (znajdującej się zazwyczaj po prawej stronie)

Identyfikacja na podstawie cech komory silnika



1. Górna pokrywa silnika z logo „E=LECTRIC”
2. Pomarańczowa wiązka przewodów wysokiego napięcia

ODŁĄCZENIE ZASILANIA UKŁADU WYSOKIEGO NAPIĘCIA

▲ OSTRZEŻENIE: Systemy bezpieczeństwa układu wysokiego napięcia w uszkodzonych, na skutek zderzenia, pojazdach z napędem elektrycznym mogły również ulec uszkodzeniu i mogą stanowić potencjalne zagrożenie porażeniem prądem o wysokim napięciu. Należy zachować ostrożność i stosować osobiste wyposażenie ochronne. Zdejmij wszelką metalową biżuterię, w tym zegarki i pierścionki. Niezastosowanie się do tych zaleceń może spowodować poważne obrażenia ciała lub śmierć.

Zapłon jest **WYŁĄCZONY** — Zawsze gdy zapłon jest **WYŁĄCZONY** (a pojazd nie jest ładowany), układ wysokiego napięcia jest odizolowany.

Złącze serwisowe akumulatora wysokonapięciowego — Zawsze po wyjęciu jednego ze złączy serwisowych akumulatorów wysokonapięciowych, układ wysokiego napięcia jest odizolowany.

Procedura dezaktywacji

Sposób 1

Jeśli nie można uzyskać dostępu do akumulatora, przejdź do sposobu nr 2.

1. Sprawdź, czy układ wysokiego napięcia jest zasilany.



E152565

2. Jeśli układ wysokiego napięcia jest aktywny, naciśnij przycisk START jeden raz.



E171186

3. Odłącz przewód akumulatora 12 V.

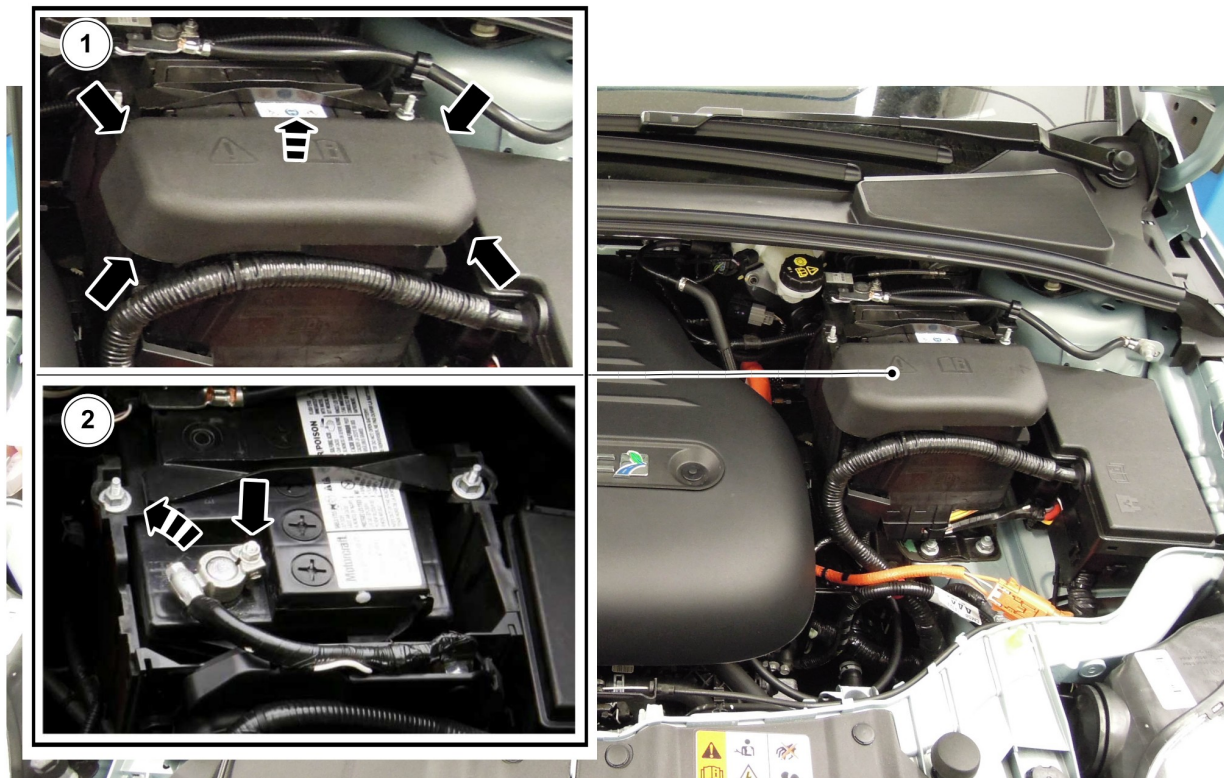

E152562

Sposób 2

WSKAZÓWKA: Aby uzyskać dostęp do górnego złącza serwisowego akumulatora wysokonapięciowego, należy opuścić oparcie tylnego siedzenia dzielonego w części 60%.

Jeśli nie można opuścić oparcia tylnego siedzenia, przejdź do sposobu nr 3.

1. Odszukaj dźwignię zwalniającą oparcia, która znajduje się u góry oparcia.



E152563

2. Zdejmij pokrywę, aby uzyskać dostęp do górnego złącza serwisowego akumulatora wysokonapięciowego.

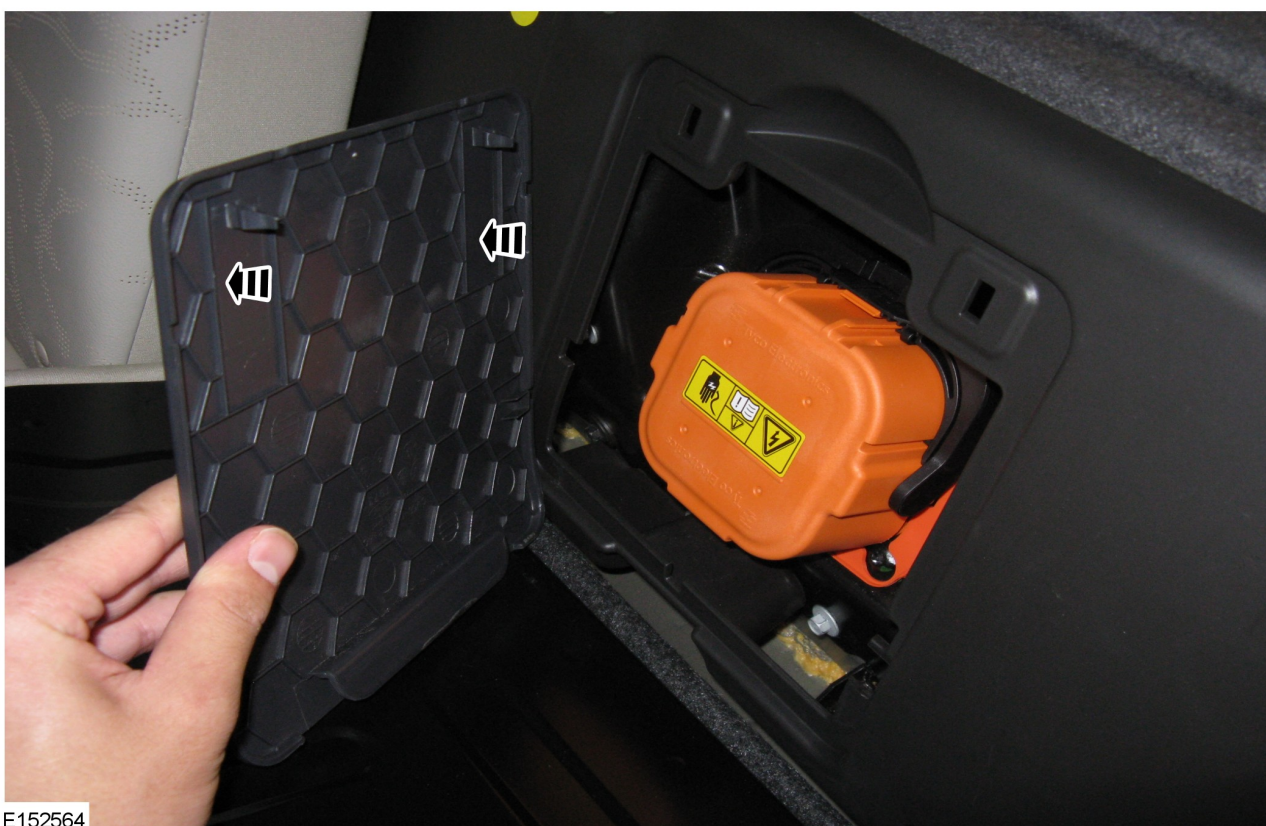

E152564

3. Wciśnij zaczep zwalniający u góry złącza serwisowego i przestaw uchwyt zwalniający do dołu o około 45 stopni.



E152566

4. Wciśnij ponownie zaczep zwalniający i przestaw uchwyt o kolejne 45 stopni, do całkowitego zwolnienia. Pociągnij za uchwyt, aby wyjąć górne złącze serwisowe.

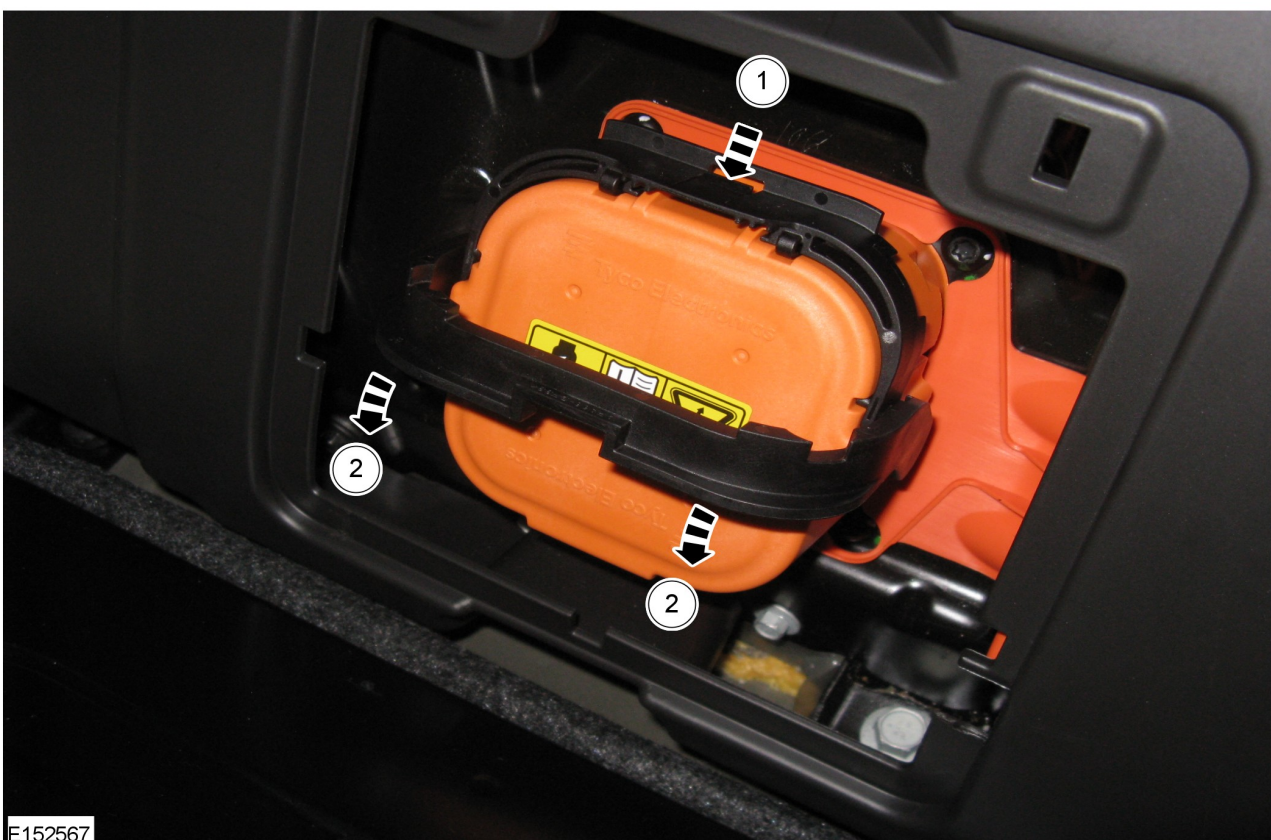

E152567

Sposób 3

WSKAZÓWKA: Dolne złącze serwisowe można wyjąć w taki sam sposób jak górne. Aby uzyskać dostęp do dolnego złącza serwisowego akumulatora wysokonapięciowego, należy podnieść tył pojazdu odpowiednim podnośnikiem.

1. Dolne złącze serwisowe akumulatora wysokonapięciowego znajduje się po prawej stronie pojazdu, w okolicy tylnej opony.

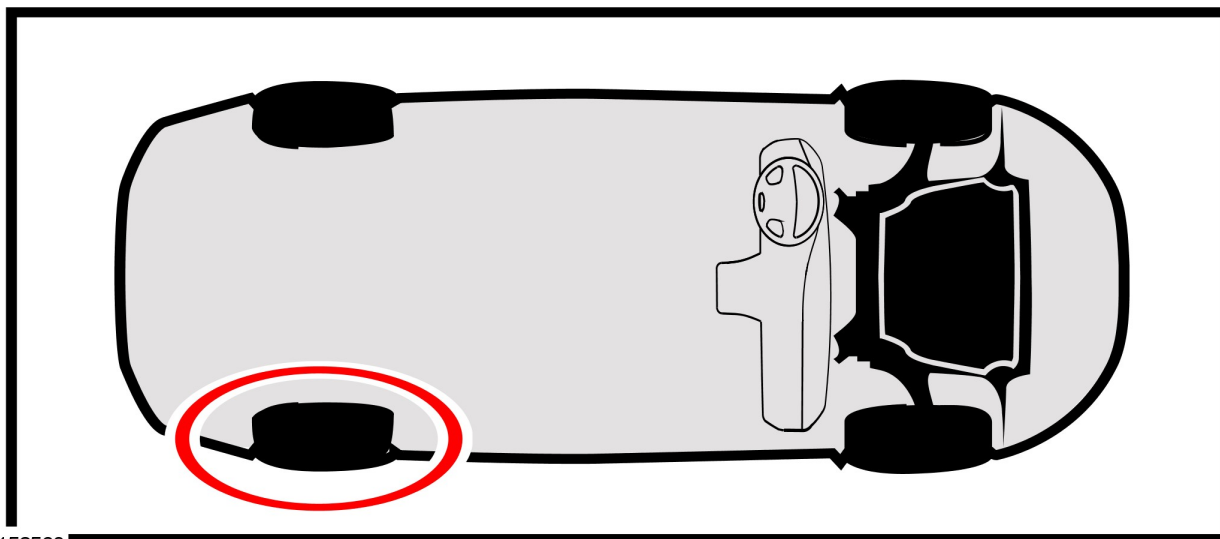

E152568

2. Zdejmij element ustalający ze wspornika linki hamulca postojowego i odsuń linkę hamulca postojowego oraz wspornik na bok. Wciśnij zaczep zwalniający z tyłu złącza serwisowego i przestaw uchwyt zwalniający o około 45 stopni w stronę przodu pojazdu. Wciśnij ponownie zaczep zwalniający i przestaw uchwyt zwalniający o kolejne 45 stopni, do całkowitego zwolnienia. Pociągnij za uchwyt, aby wyjąć dolne złącze serwisowe.

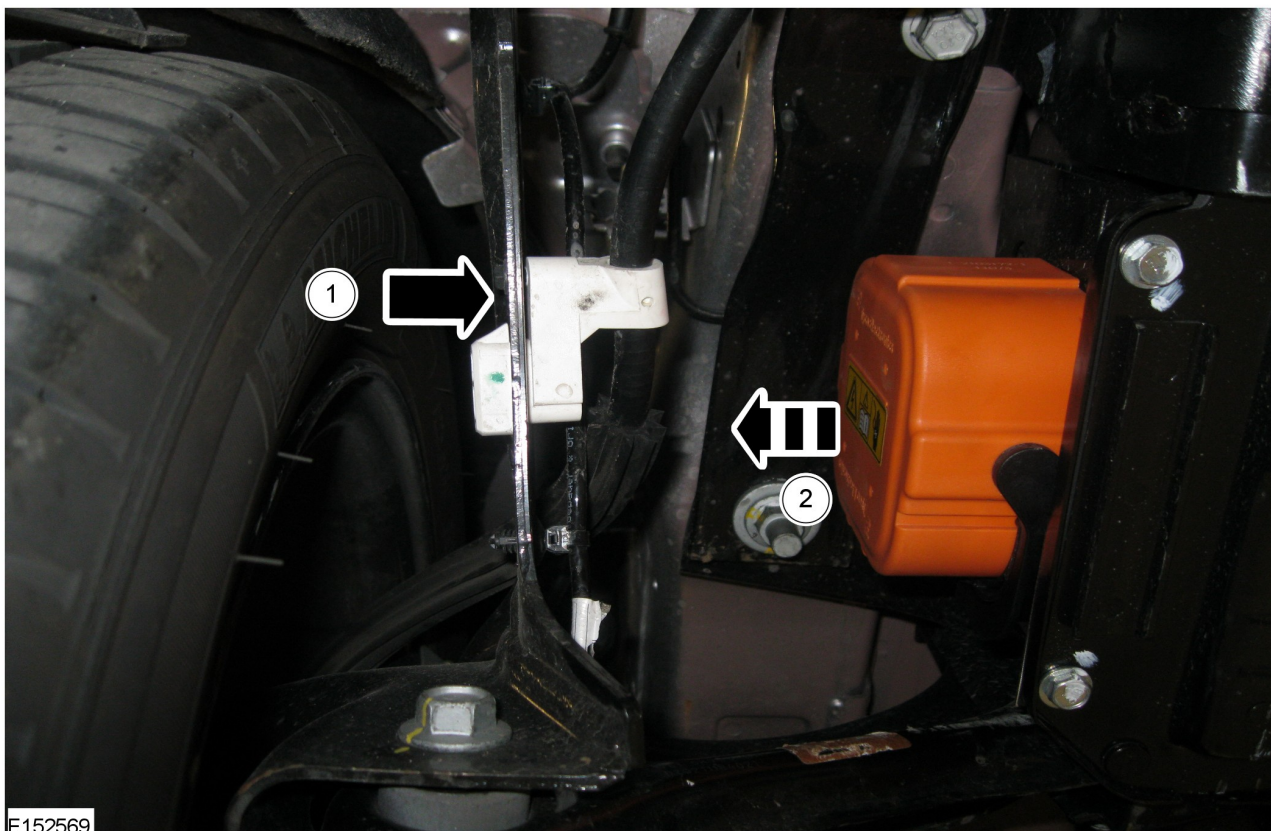

E152569

Ford Fusion



E137293

06/2002 – >

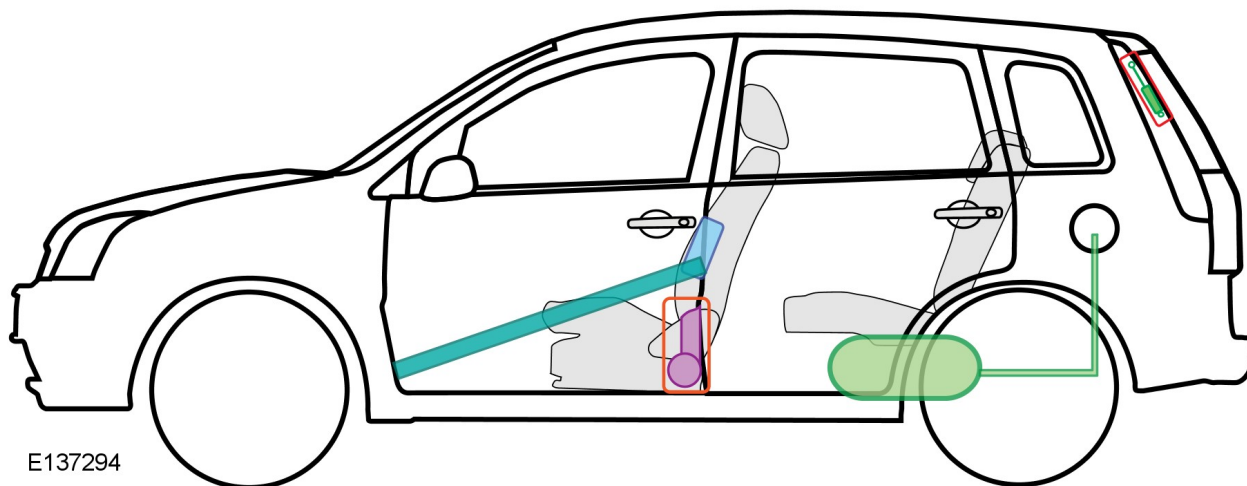
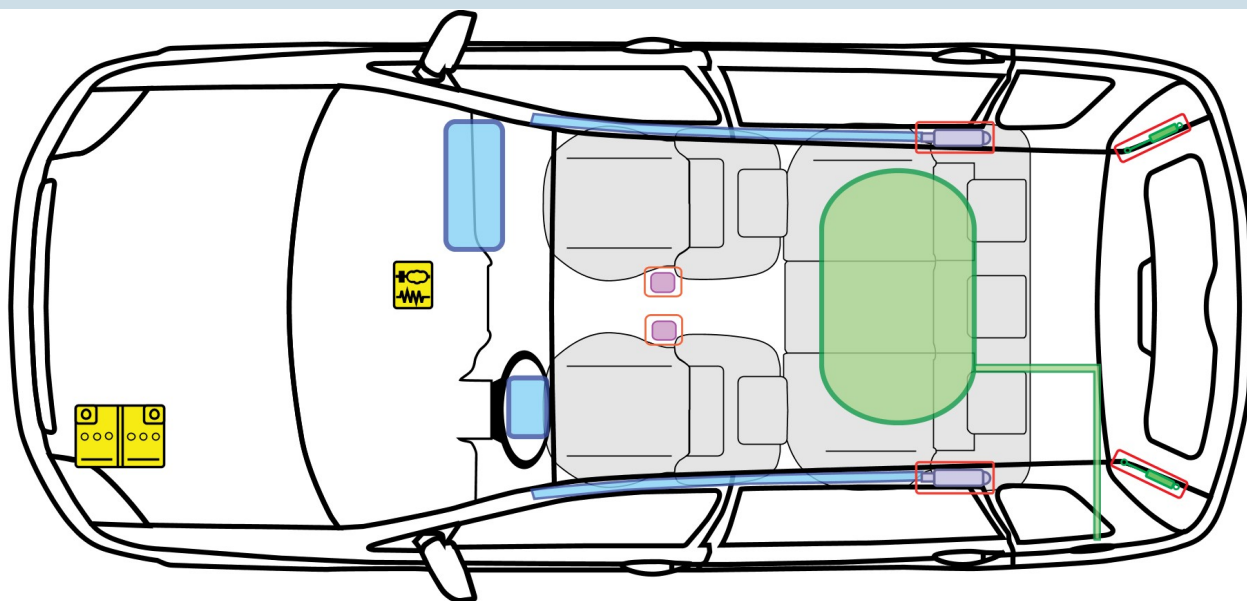

E137294

Legenda

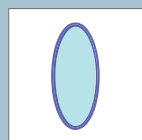

Ochronna poduszka powietrzna

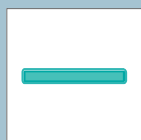

Wzmocnienia konstrukcji



Sterownik

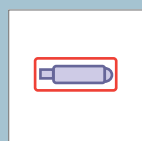

Generator gazu

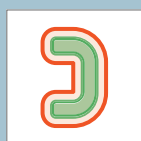

Aktywna ochrona w przypadku wywrócenia pojazdu
Sprężyna gazowa

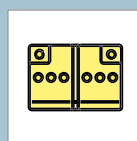

Akumulator

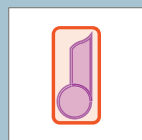

Napinaczy pasów

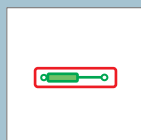

Zbiornik paliwa



E137287

02/2006 – >

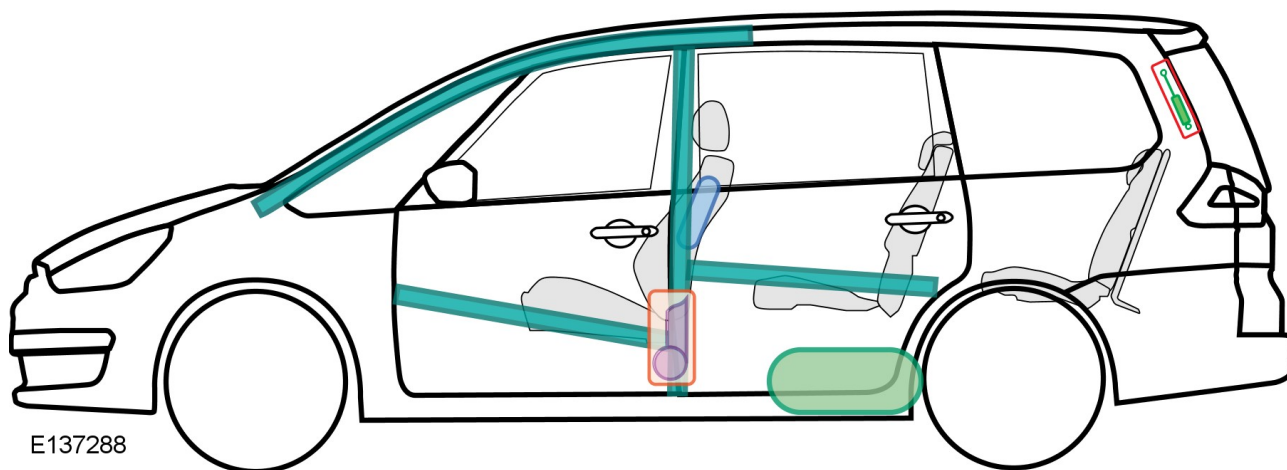
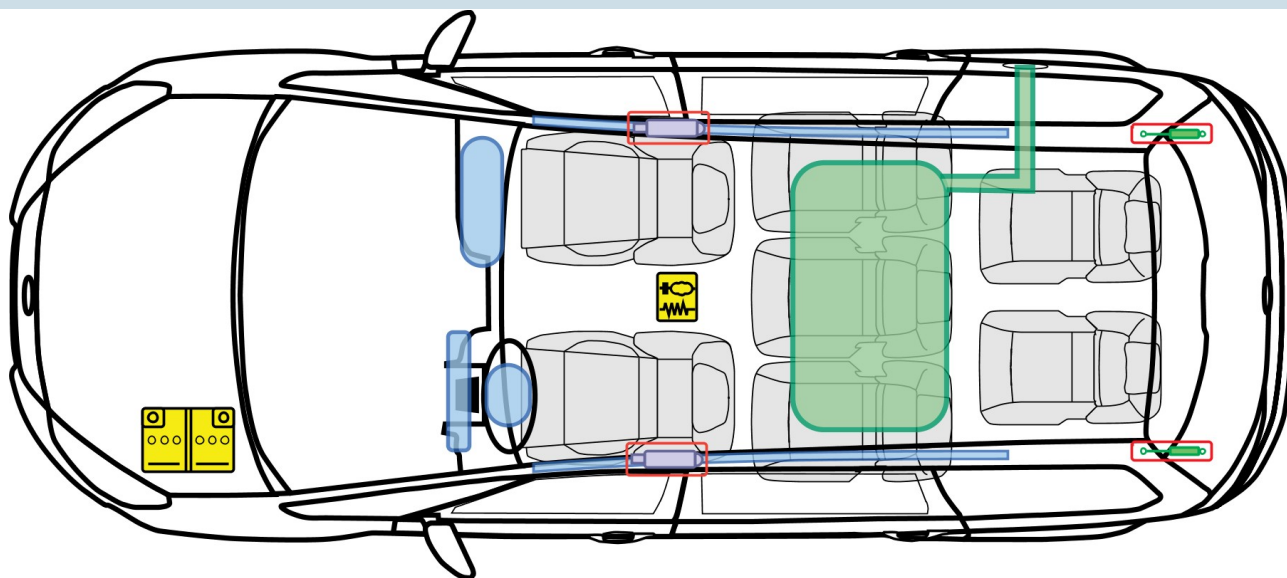

E137288

Legenda

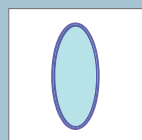

Ochronna poduszka powietrzna

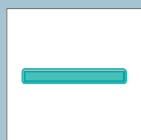

Wzmocnienia konstrukcji



Sterownik

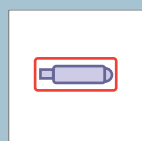

Generator gazu

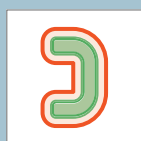

Aktywna ochrona w przypadku wywrócenia pojazdu
Sprężyna gazowa

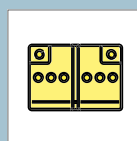

Akumulator

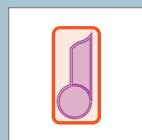

Napinacze pasów

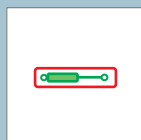

Zbiornik paliwa

FordGalaxy



E137289



04/2000 – 02/2006

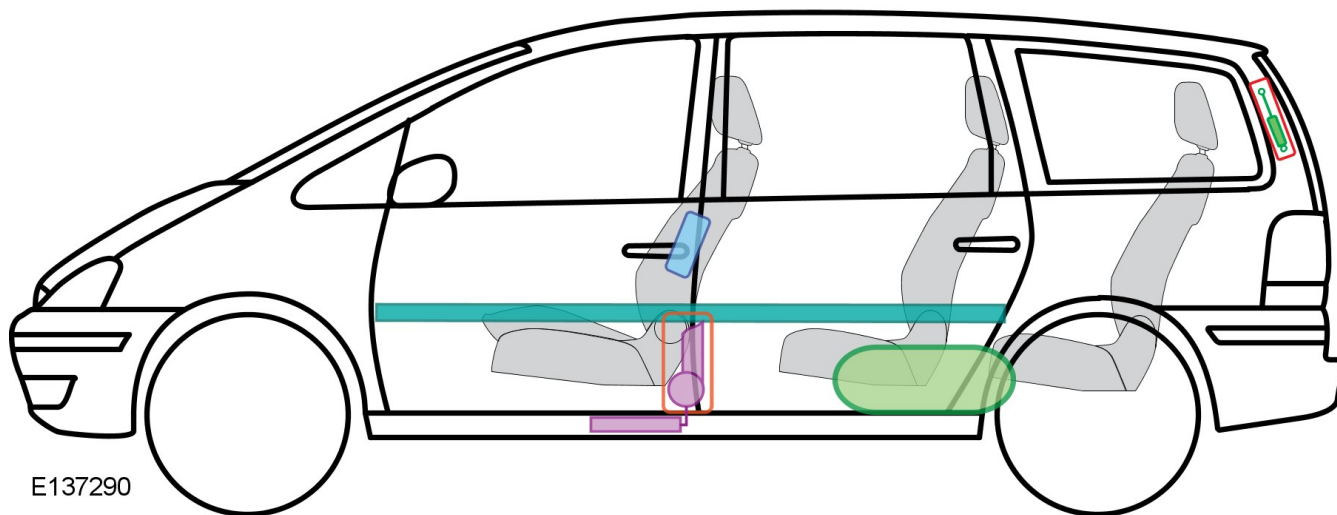
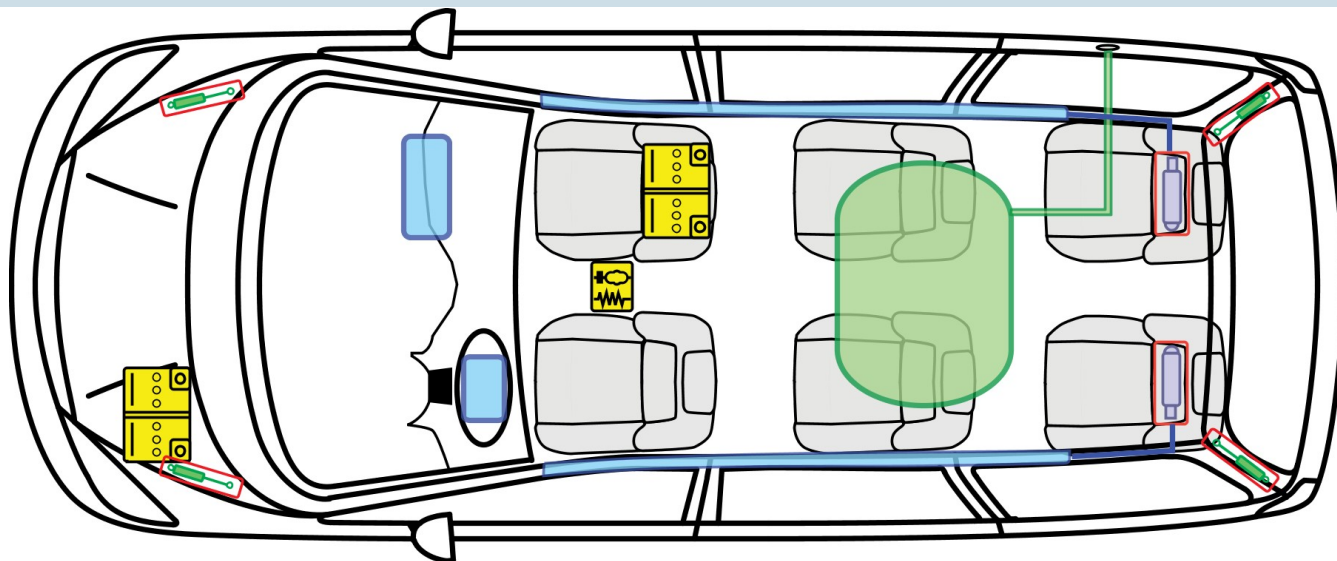

E137290

Legenda

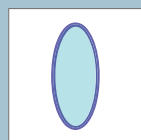

Ochronna poduszka powietrzna

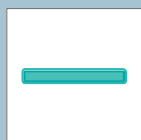

Wzmocnienia konstrukcji



Sterownik

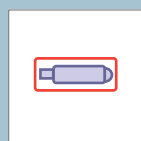

Generator gazu

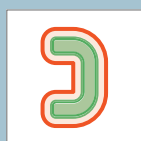

Aktywna ochrona w przypadku wywrócenia pojazdu
Sprężyna gazowa

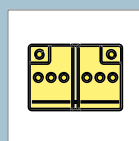

Akumulator

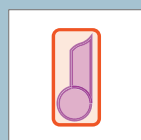

Napinacze pasów

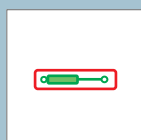

Zbiornik paliwa



E137274

08/2008 – >

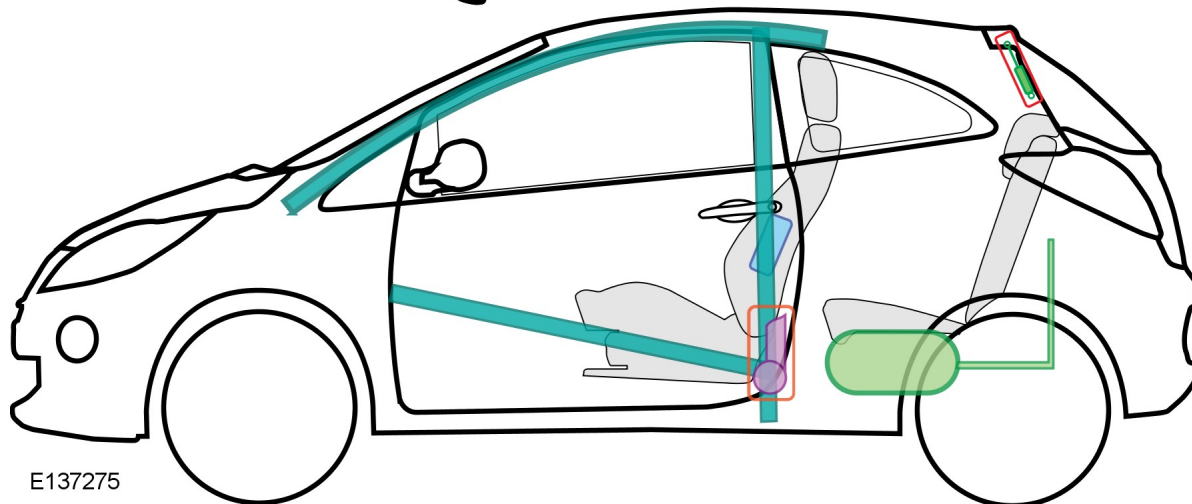
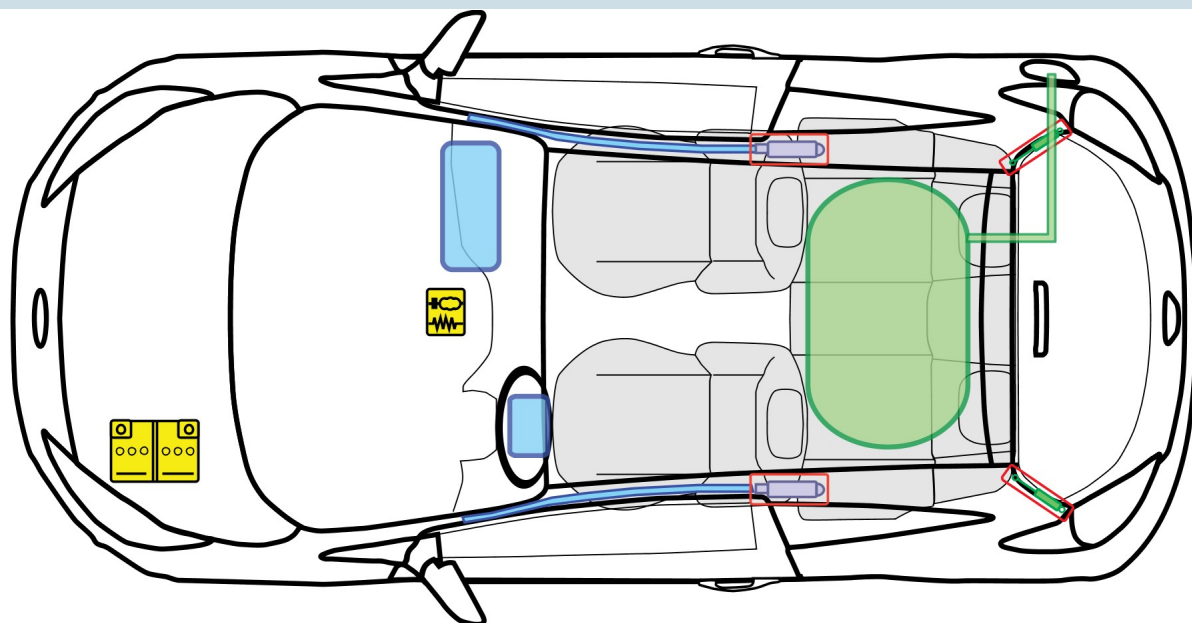

E137275

Legenda

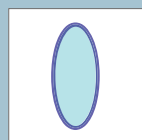

Ochronna poduszka powietrzna

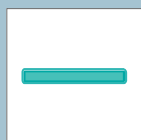

Wzmocnienia konstrukcji



Sterownik

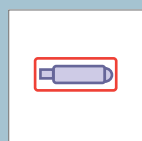

Generator gazu

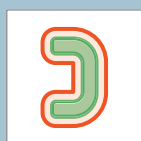

Aktywna ochrona w przypadku wywrócenia pojazdu
Sprężyna gazowa

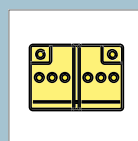

Akumulator

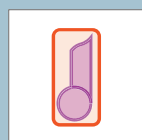

Napinaczy pasów



Zbiornik paliwa

K

FordKA



E137277



09/1996 – 07/2008

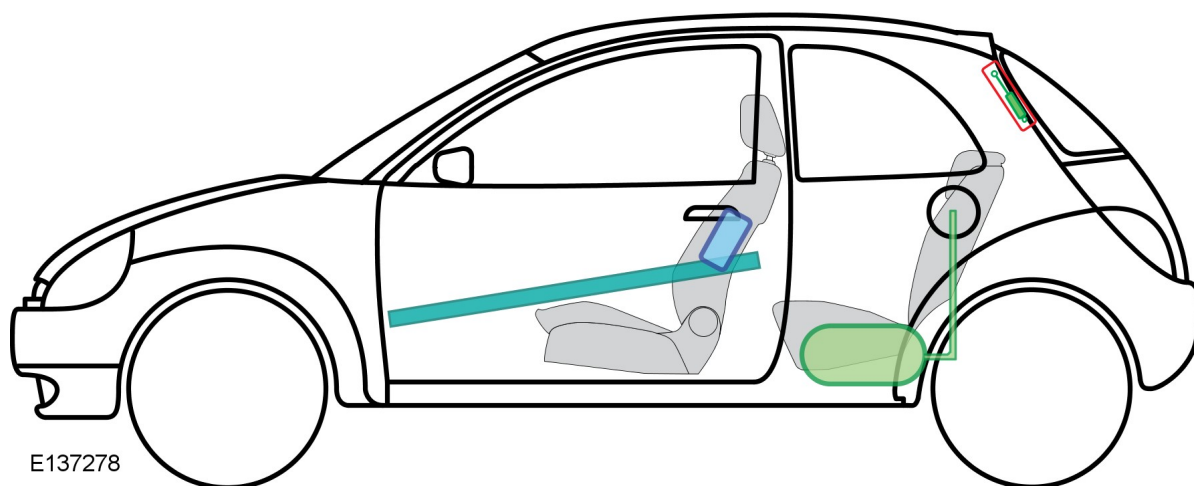
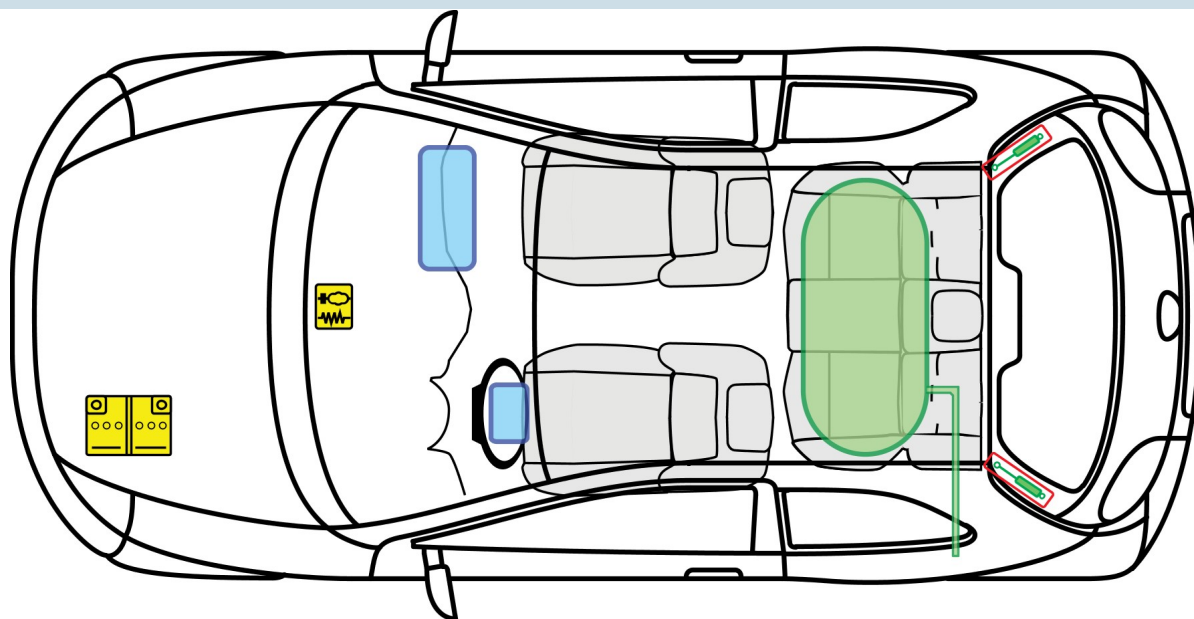

E137278

Legenda

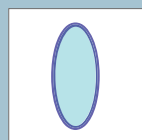

Ochronna poduszka powietrzna

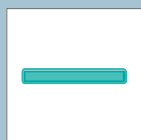

Wzmocnienia konstrukcji



Sterownik

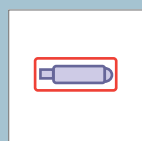

Generator gazu

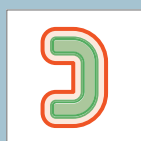

Aktywna ochrona w przypadku wywrócenia pojazdu

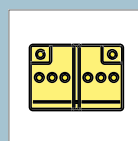

Akumulator

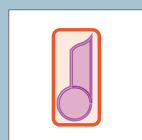

Napinacze pasów

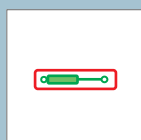

Sprężyna gazowa



Zbiornik paliwa

K

Ford Kuga



E137203

02/2008 – 10/2012

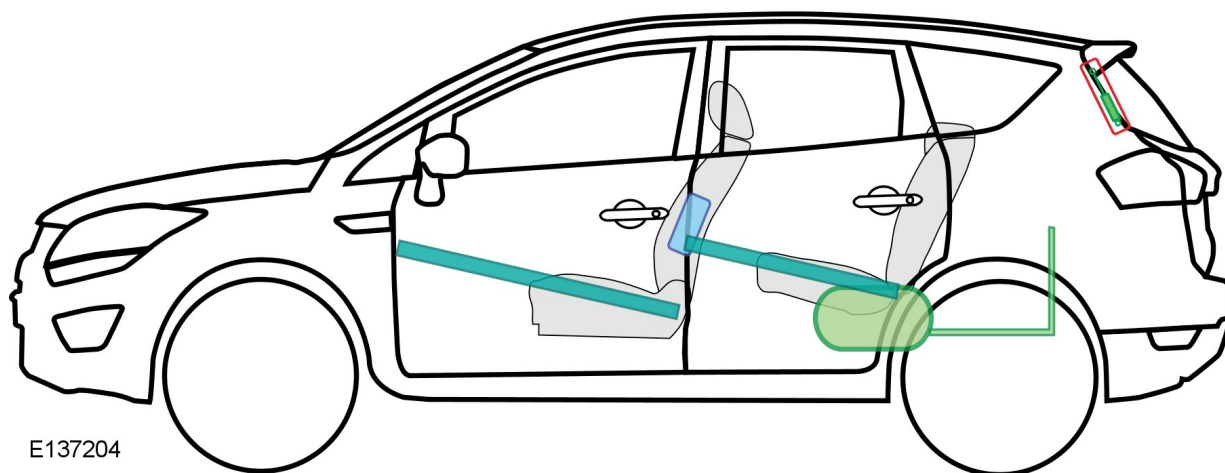
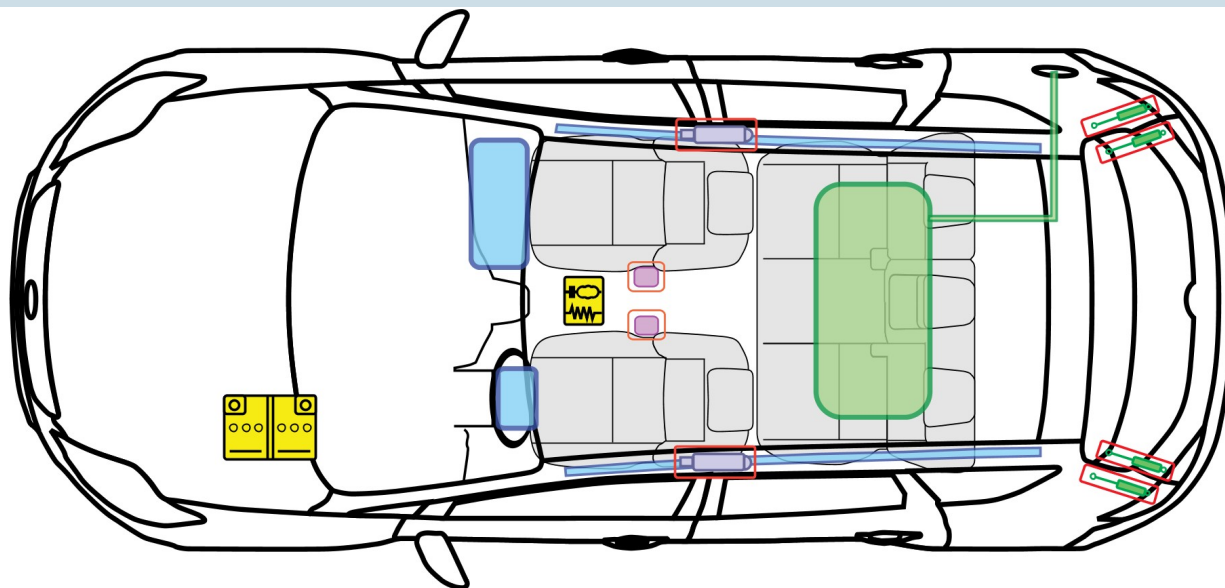

E137204

Legenda

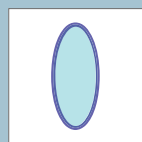

Ochronna poduszka powietrzna

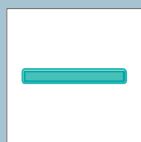

Wzmocnienia konstrukcji



Sterownik

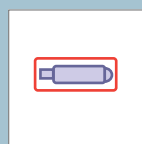

Generator gazu



Aktywna ochrona w przypadku wywrócenia pojazdu
Sprężyna gazowa

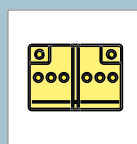

Akumulator

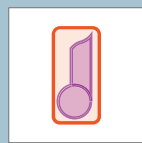

Napinacze pasów

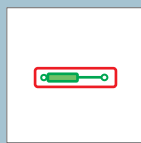

Zbiornik paliwa

K



FordKuga



E161728



10/2012 – >

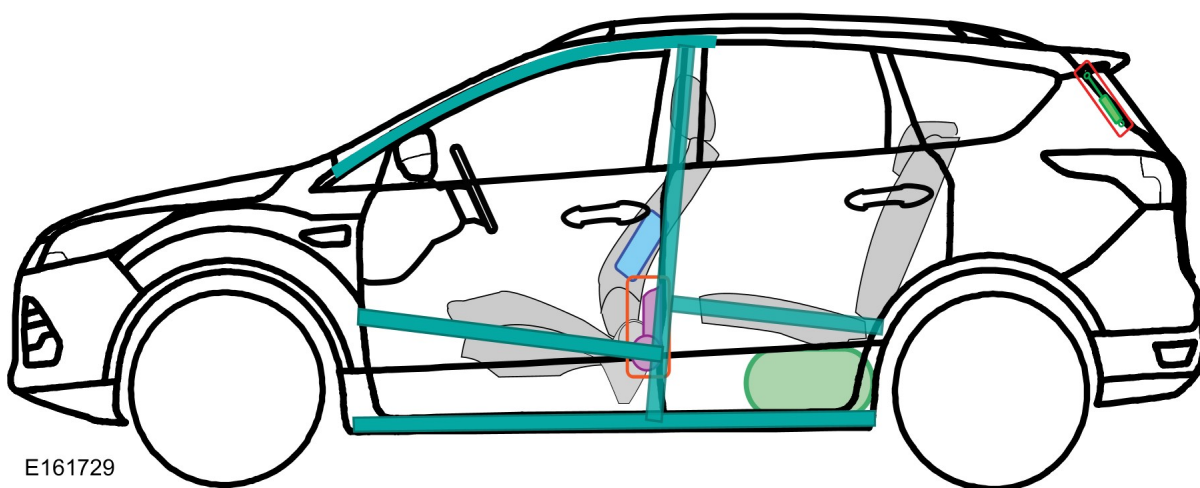
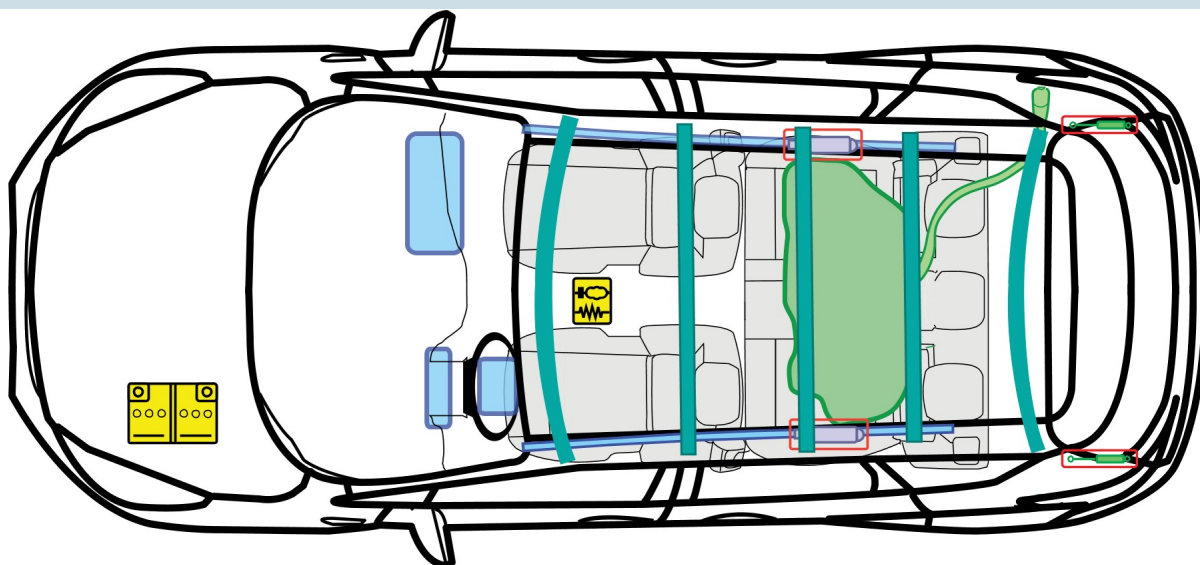

E161729

Legenda

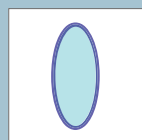

Ochronna poduszka powietrzna

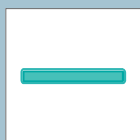

Wzmocnienia konstrukcji



Sterownik

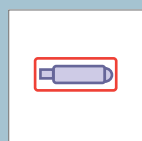

Generator gazu



Aktywna ochrona w przypadku wywrócenia pojazdu

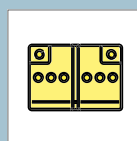

Akumulator

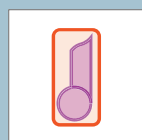

Napinacze pasów

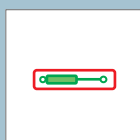

Sprężyna gazowa



Zbiornik paliwa

K



Ford Mondeo Kombi



E137312



10/2000 – 02/2007

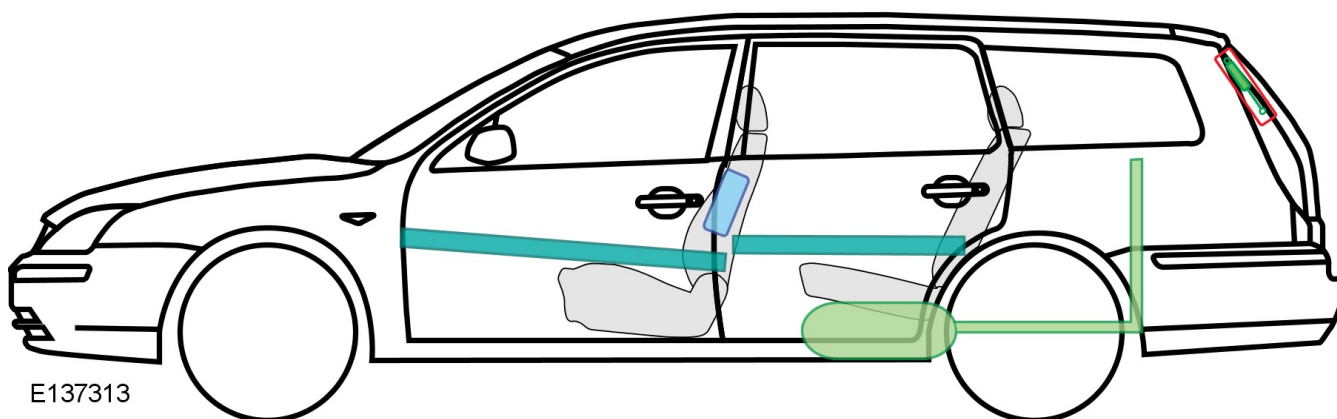
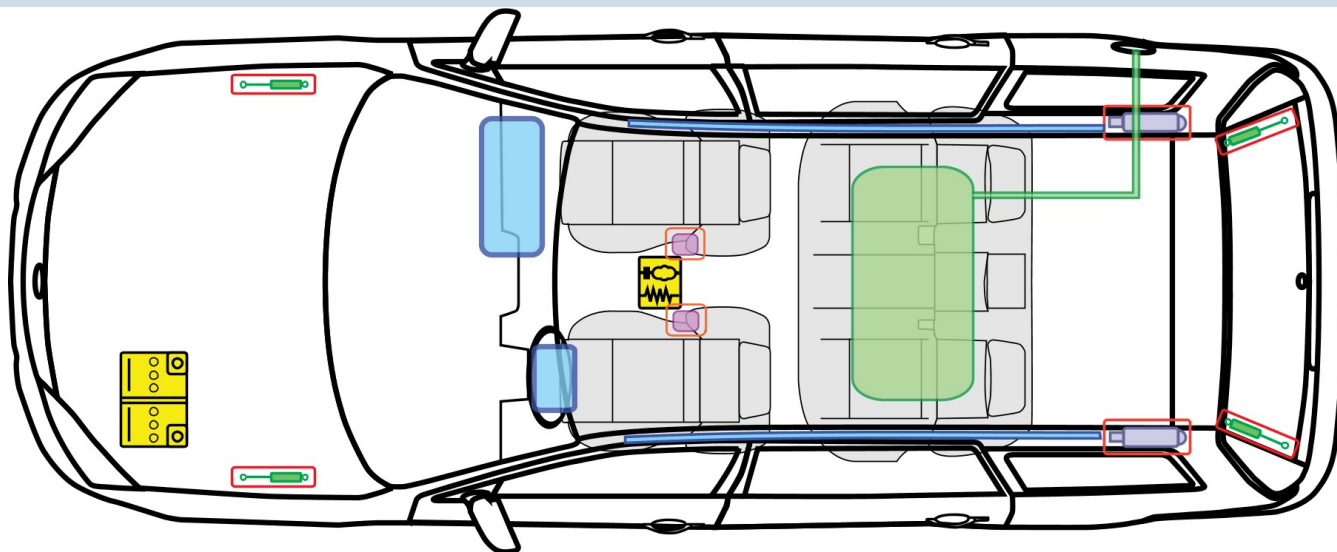

E137313

Legenda

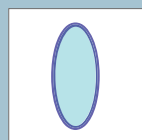

Ochronna poduszka powietrzna

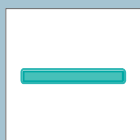

Wzmocnienia konstrukcji



Sterownik

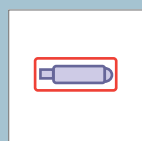

Generator gazu



Aktywna ochrona w przypadku wywrócenia pojazdu
Sprężyna gazowa

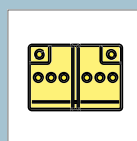

Akumulator

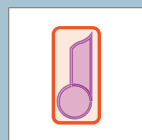

Napinacze pasów

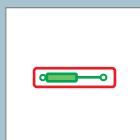

Zbiornik paliwa

Ford Mondeo Kombi



E137327

02/2007 – >

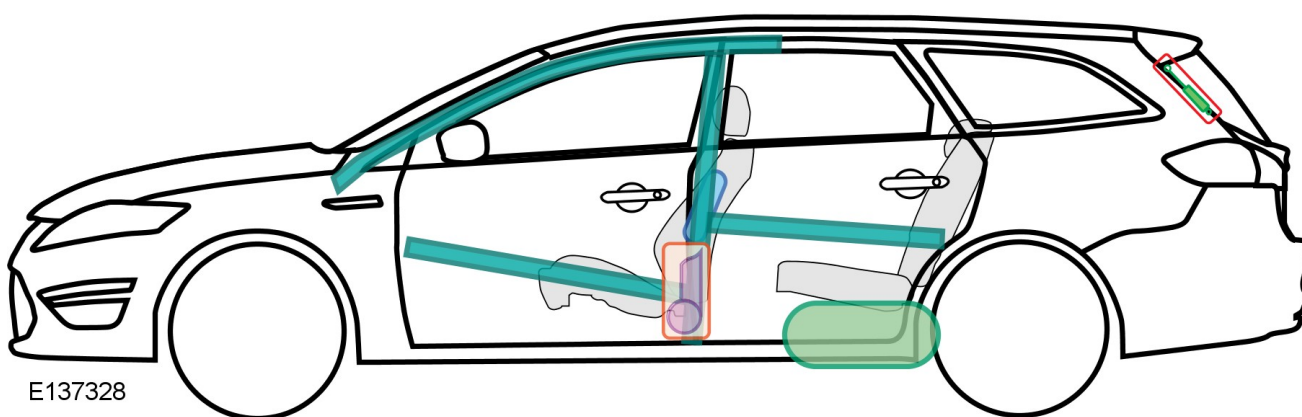
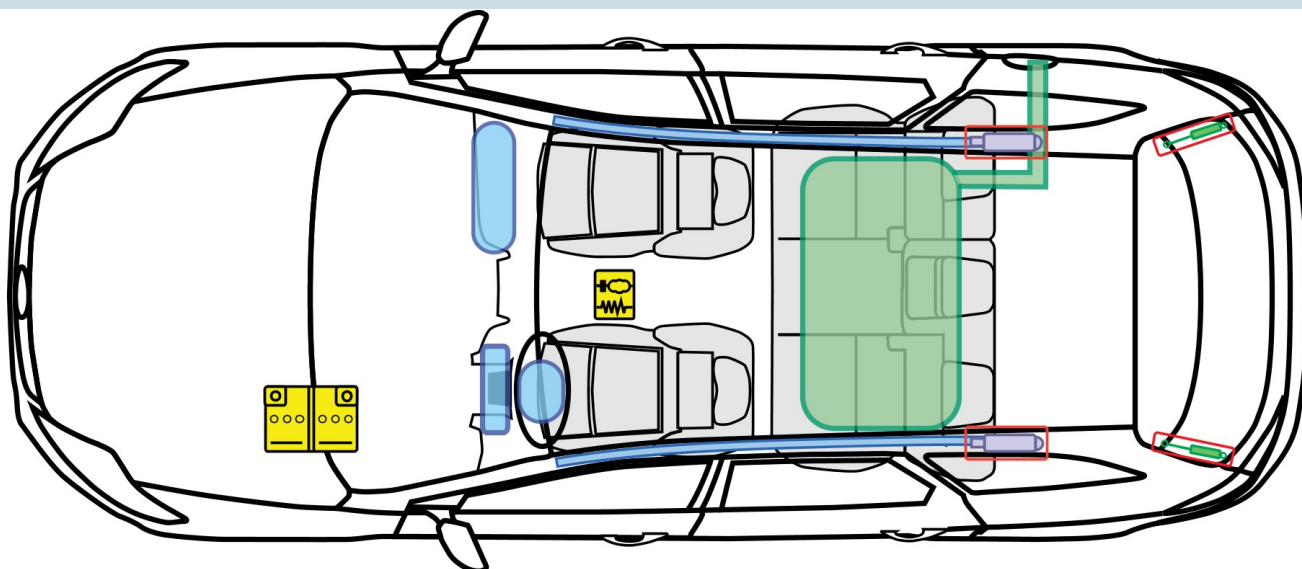

E137328

Legenda

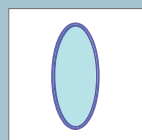

Ochronna poduszka powietrzna

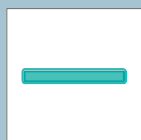

Wzmocnienia konstrukcji



Sterownik

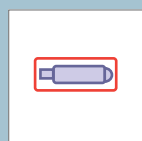

Generator gazu

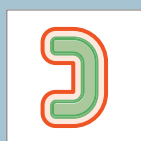

Aktywna ochrona w przypadku wywrócenia pojazdu

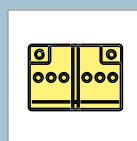

Akumulator

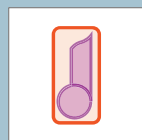

Napinacze pasów

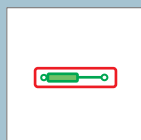

Sprężyna gazowa



Zbiornik paliwa

Ford Mondeo - LPG Kombi



E137327

02/2007 – >

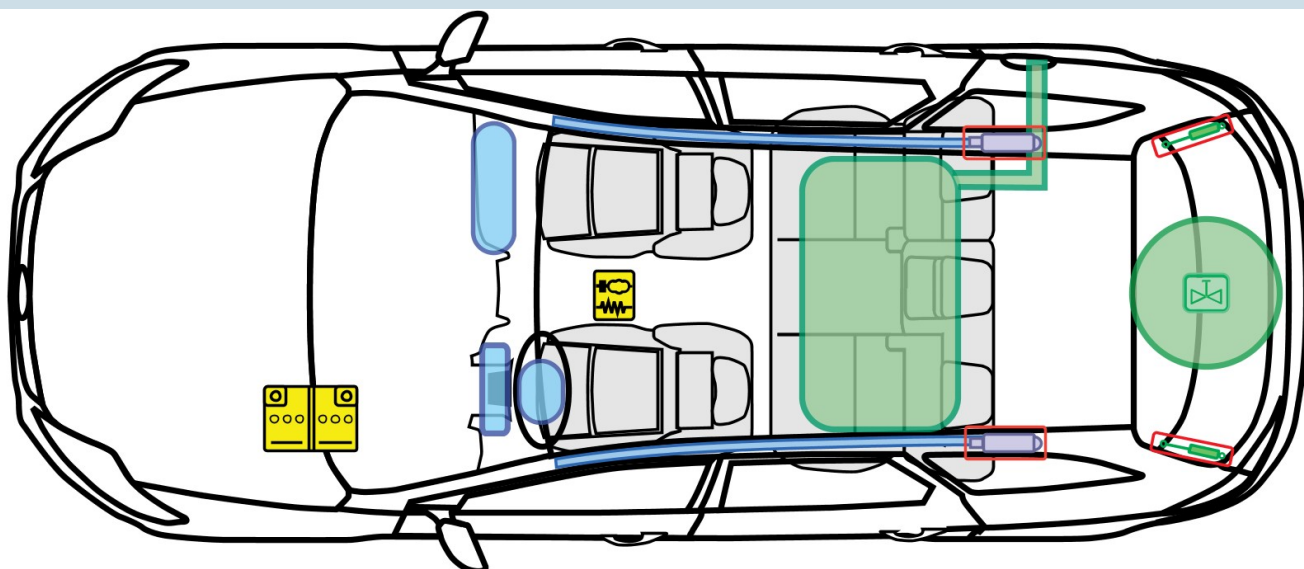

LPG

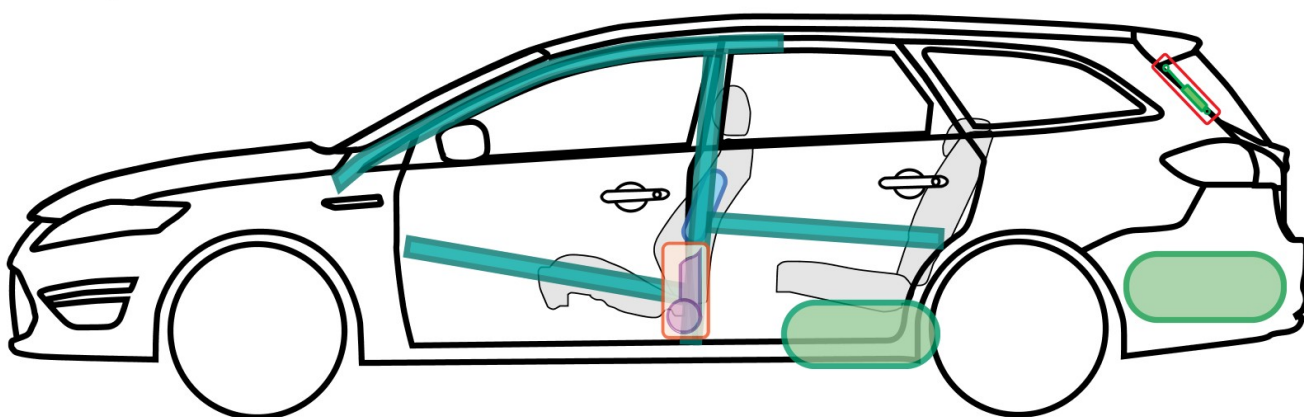

E137334

Legenda

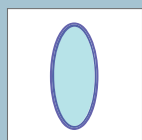

Ochronna poduszka powietrzna

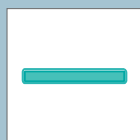

Wzmocnienia konstrukcji



Sterownik

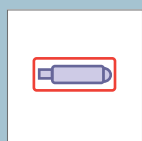

Generator gazu



Aktywna ochrona w przypadku wywrócenia pojazdu
Sprężyna gazowa

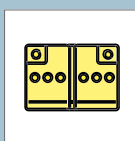

Akumulator



Zbiornika gazu

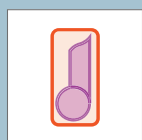

Napinacze pasów

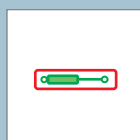

Zbiornik paliwa



Zawór bezpieczeństwa

Ford Mondeo

Wersja 4-drzwiowa







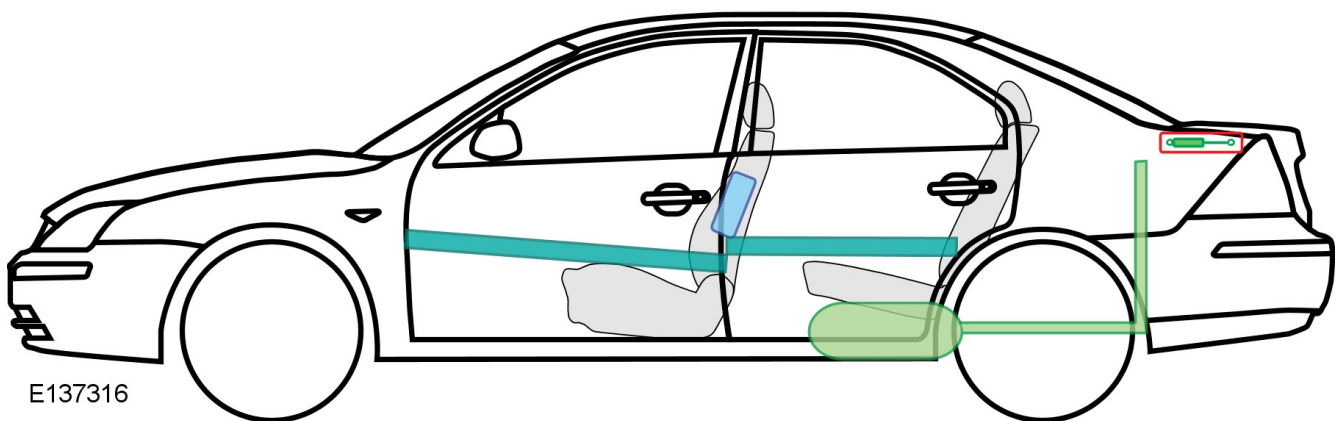
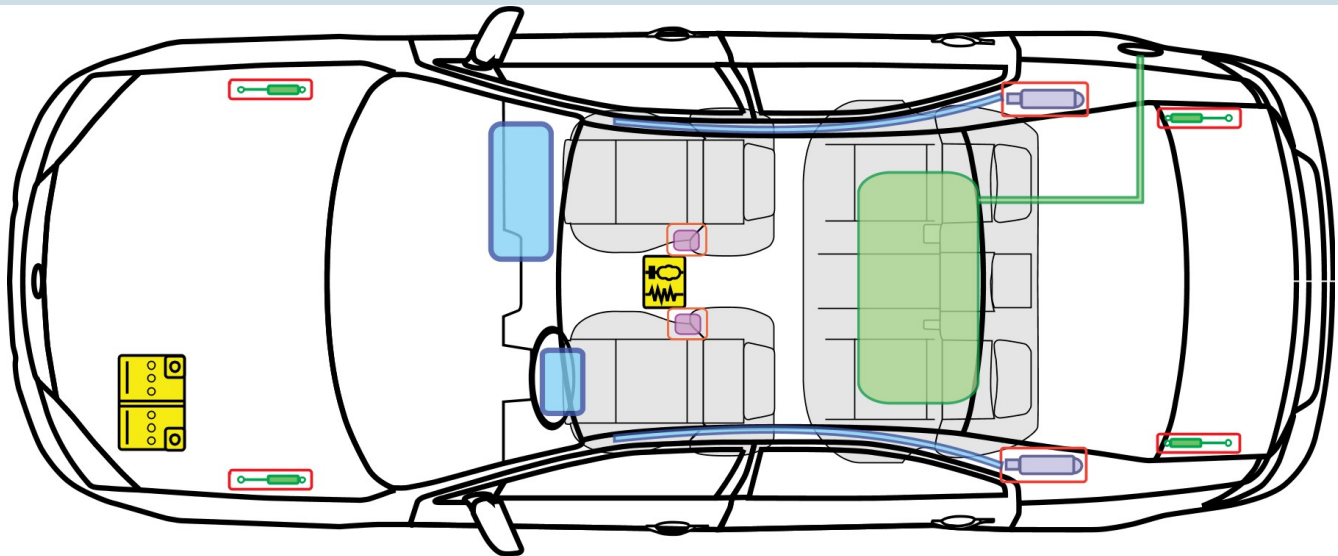

E137315

10/2000 – 02/2007

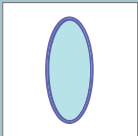

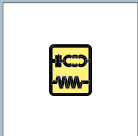
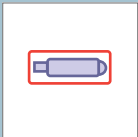
E137316

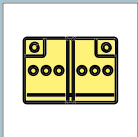
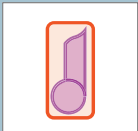
Legenda

	Ochronna poduszka powietrzna		Wzmocnienia konstrukcji		Sterownik
	Generator gazu		Aktywna ochrona w przypadku wywrócenia pojazdu		Akumulator
	Napinaczy pasów		Sprężyna gazowa		Zbiornik paliwa

M

Ford Mondeo

Wersja 4-drzwiowa



E137333

02/2007 – >

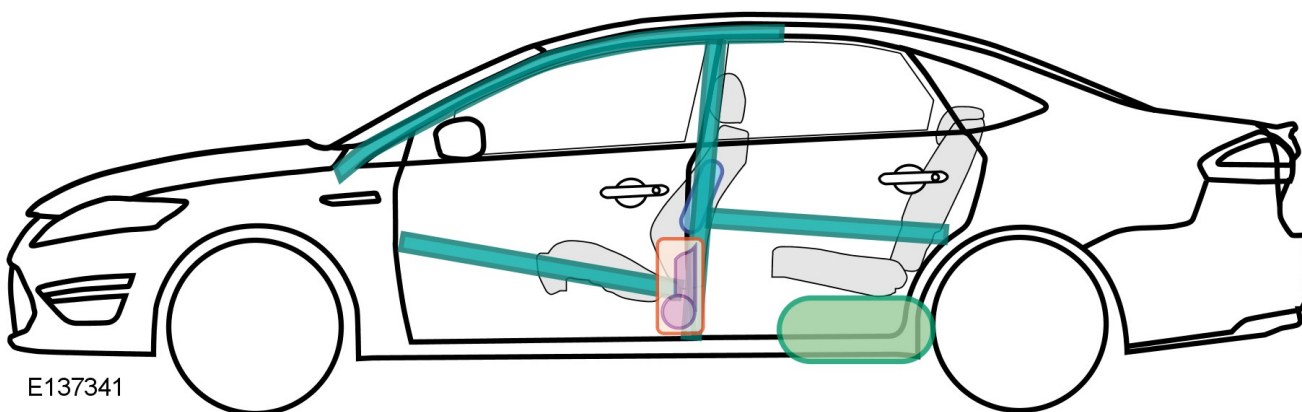
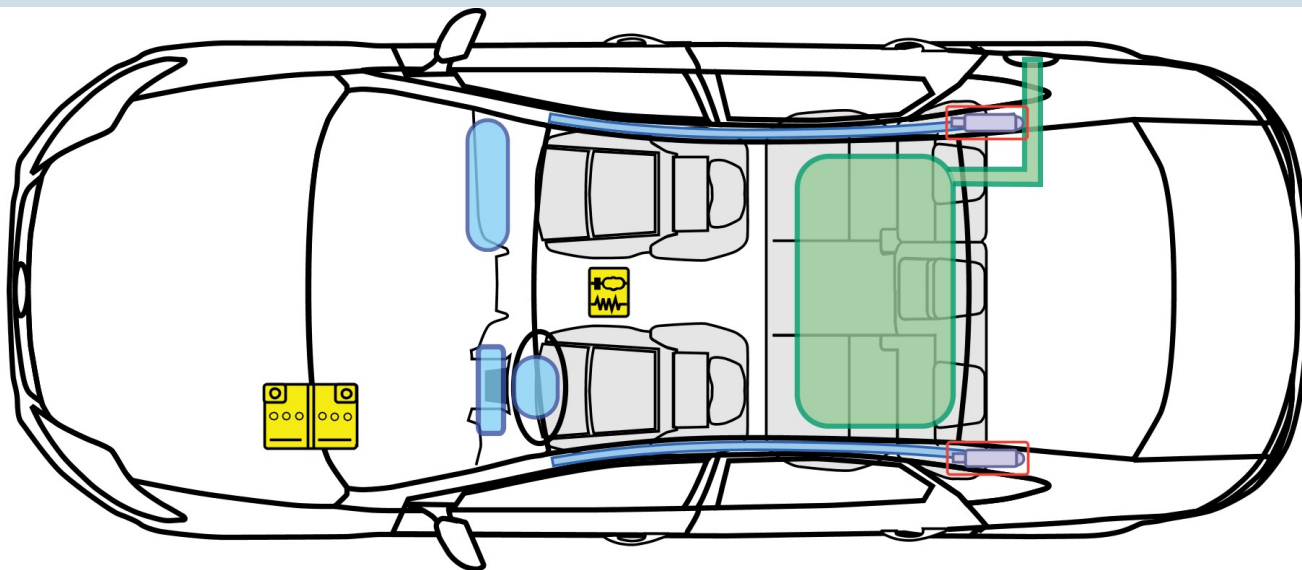

E137341

Legenda

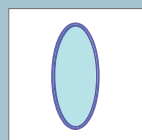

Ochronna poduszka powietrzna

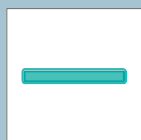

Wzmocnienia konstrukcji



Sterownik

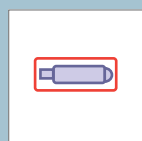

Generator gazu

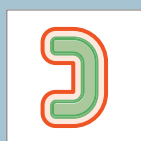

Aktywna ochrona w przypadku wywrócenia pojazdu

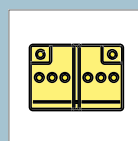

Akumulator

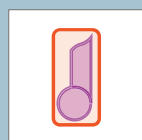

Napinacze pasów



Sprężyna gazowa



Zbiornik paliwa

Ford Mondeo - LPG

Wersja 4-drzwiowa

E137333



02/2007 – >

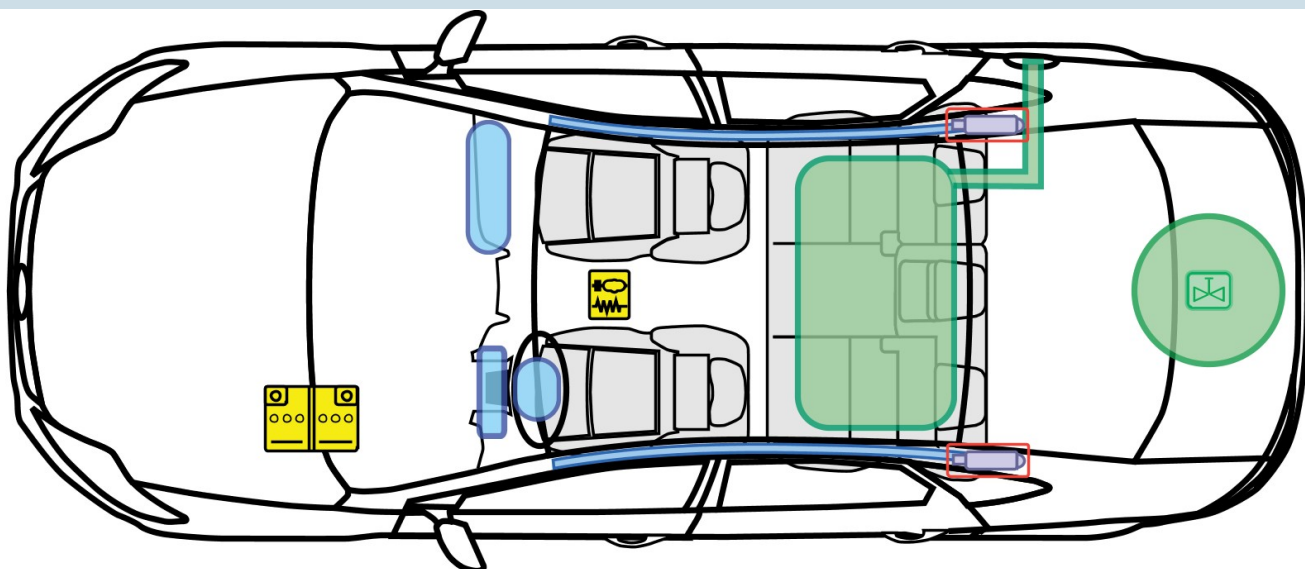

LPG

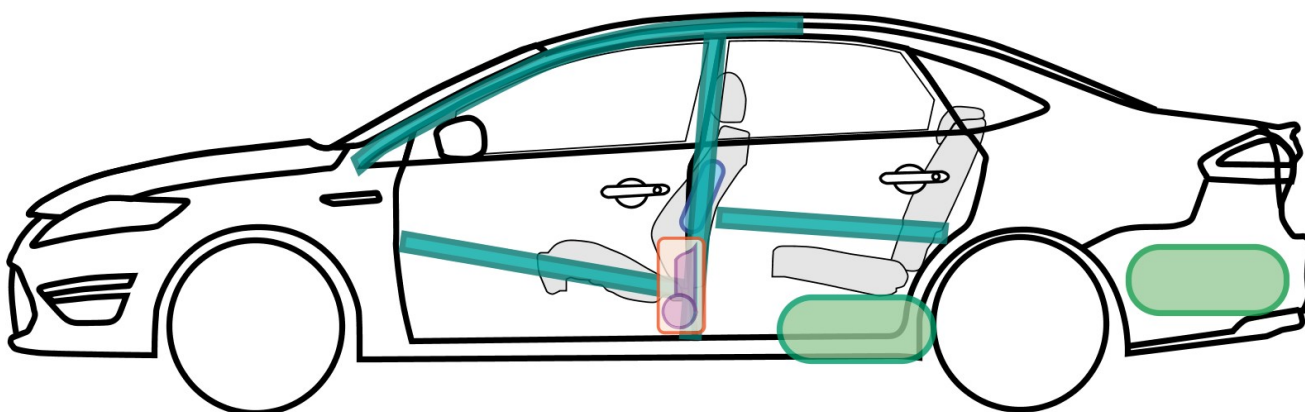

E137339

Legenda

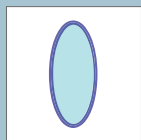

Ochronna poduszka powietrzna

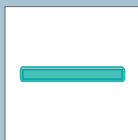

Wzmocnienia konstrukcji



Sterownik

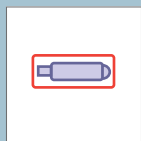

Generator gazu



Aktywna ochrona w przypadku wywrócenia pojazdu
Sprężyna gazowa

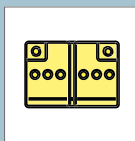

Akumulator



Zbiornika gazu

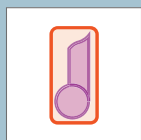

Napinaczy pasów

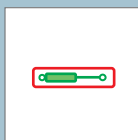

Sprężyna gazowa



Zbiornik paliwa



Zawór bezpieczeństwa

Ford Mondeo

Wersja 5-drzwiowa





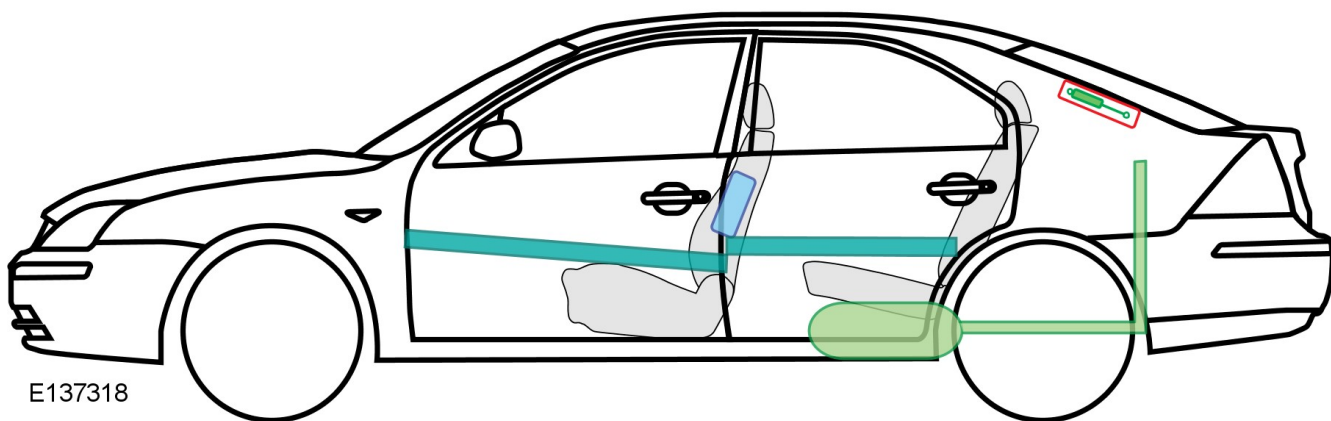
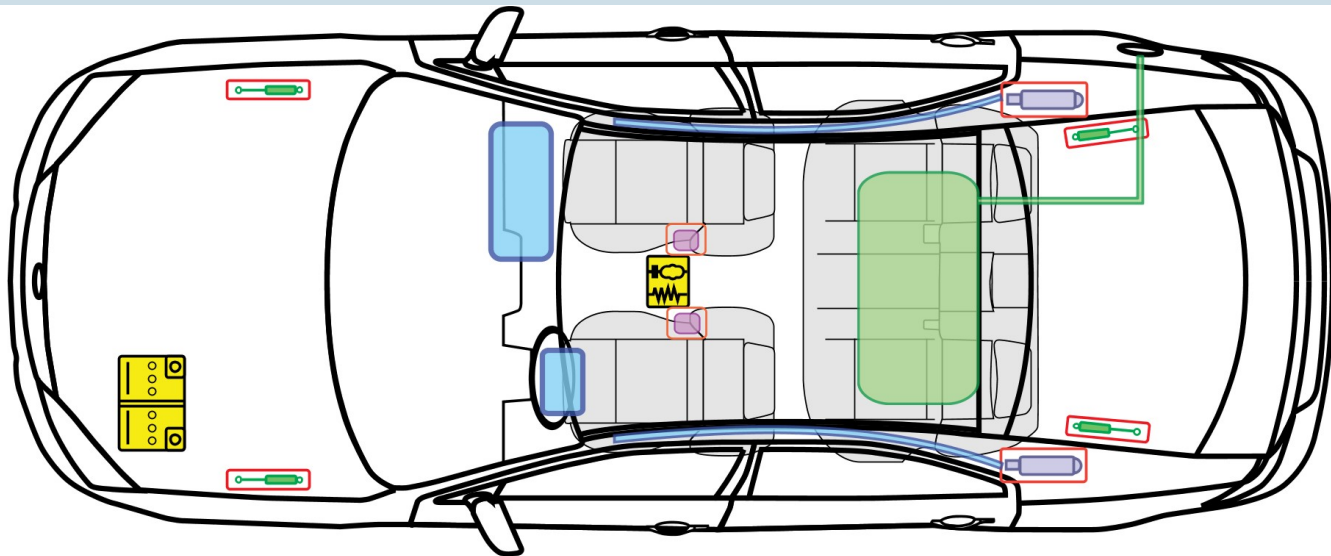



10/2000 – 02/2007

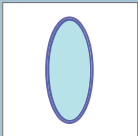

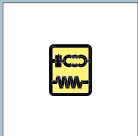
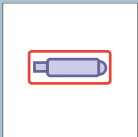
E137318

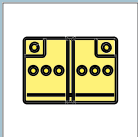
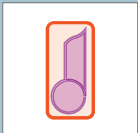
Legenda

	Ochronna poduszka powietrzna		Wzmocnienia konstrukcji		Sterownik
	Generator gazu		Aktywna ochrona w przypadku wywrócenia pojazdu		Akumulator
	Napinaczy pasów		Sprężyna gazowa		Zbiornik paliwa

Ford Mondeo

Wersja 5-drzwiowa



E137333

02/2007 – >

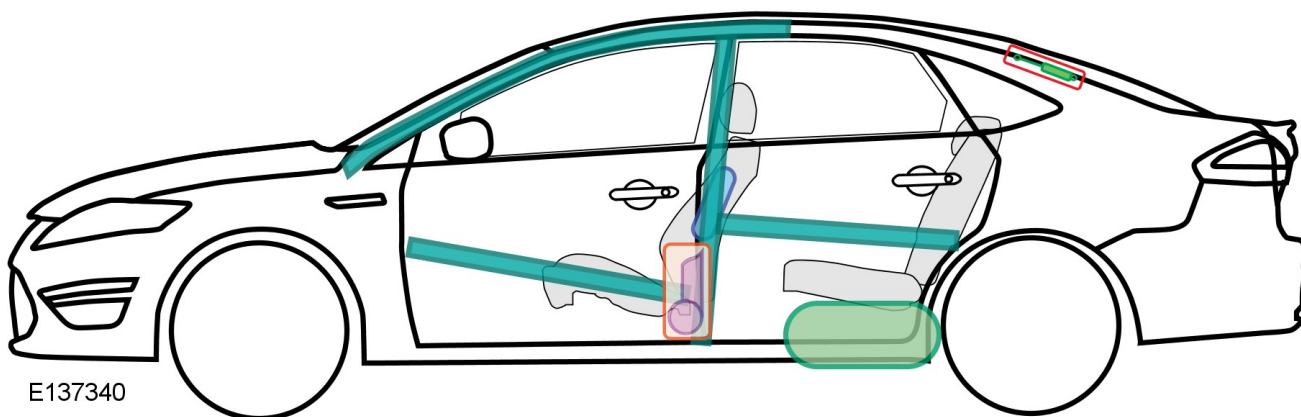
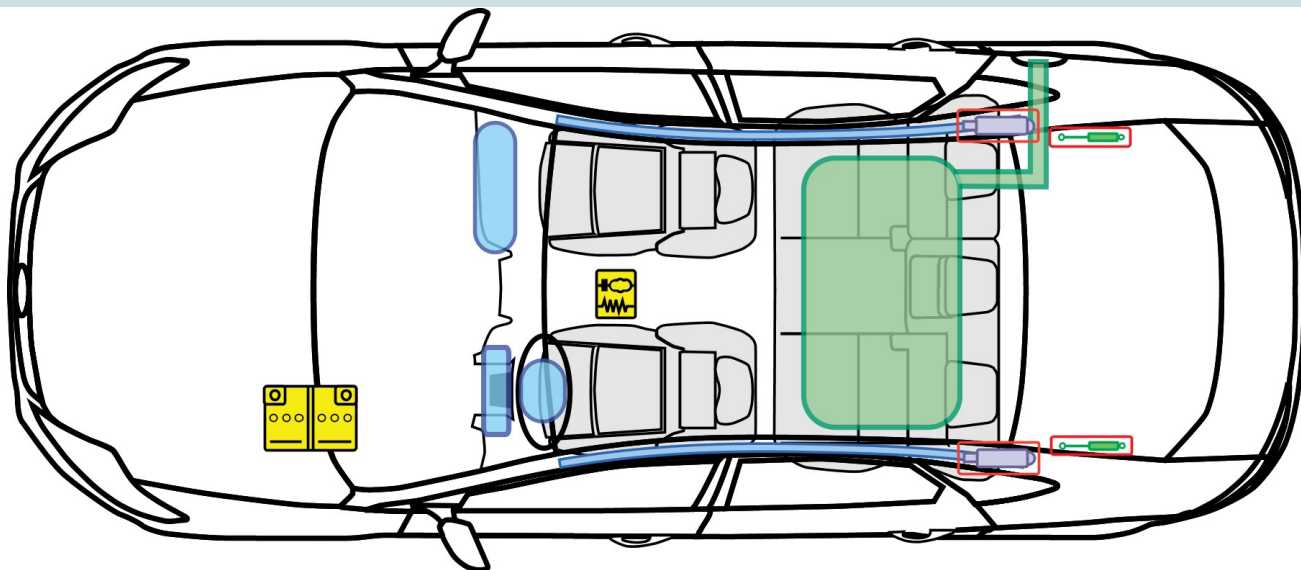

E137340

Legenda

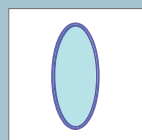

Ochronna poduszka powietrzna

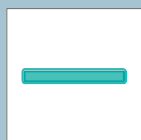

Wzmocnienia konstrukcji



Sterownik

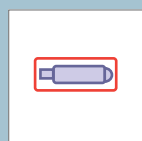

Generator gazu

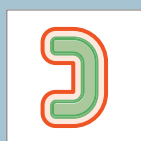

Aktywna ochrona w przypadku wywrócenia pojazdu
Sprężyna gazowa

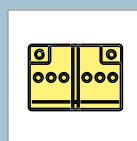

Akumulator

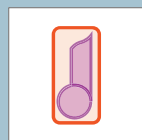

Napinacze pasów

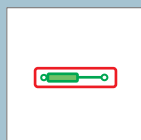

Zbiornik paliwa



Ford Mondeo - LPG

Wersja 5-drzwiowa



E137333

02/2007 – >

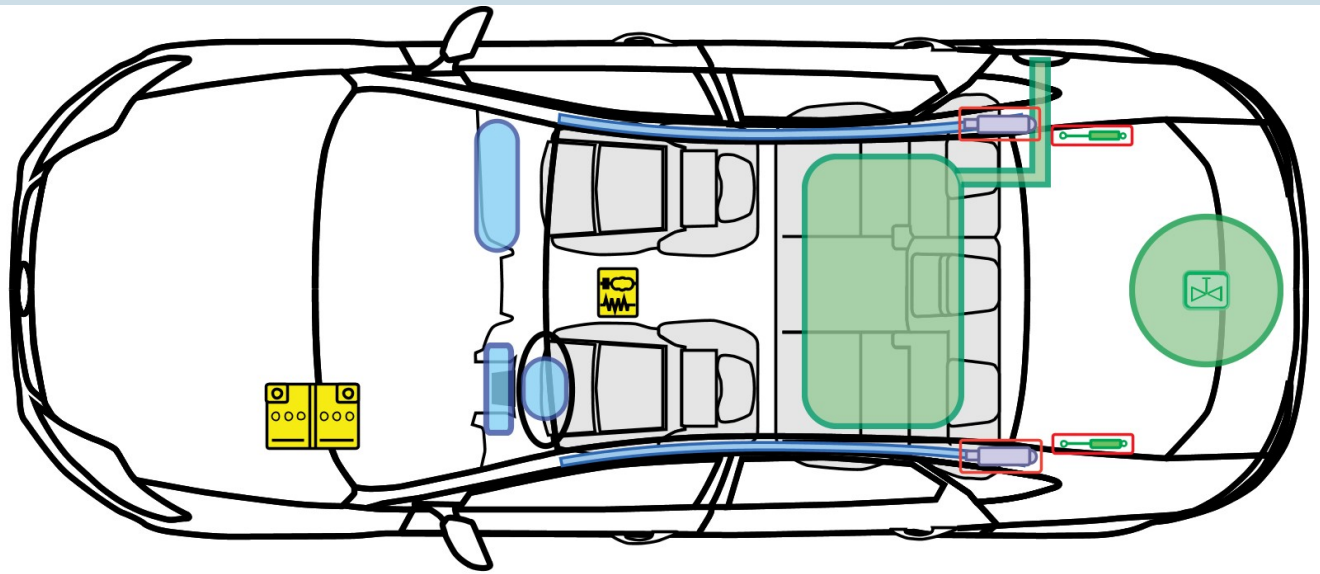



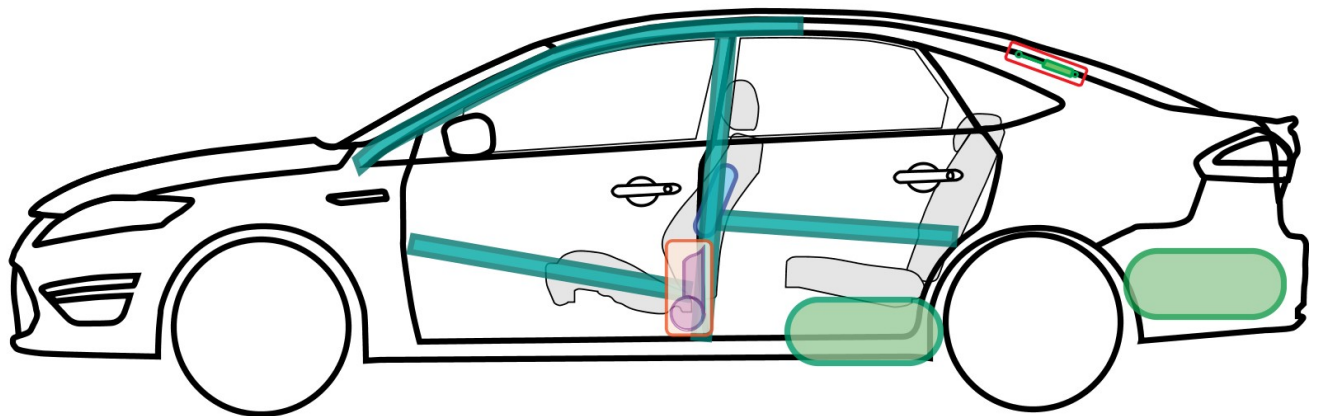



LPG

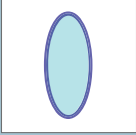
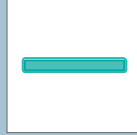
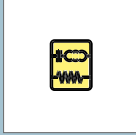
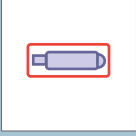

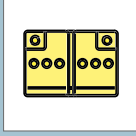
E137337

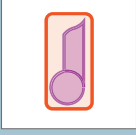
Legenda

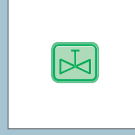
	Ochronna poduszka powietrzna		Wzmocnienia konstrukcji		Sterownik		
	Generator gazu		Aktywna ochrona w przypadku wywrócenia pojazdu		Akumulator		Zbiornika gazu
	Napinaczy pasów		Sprężyna gazowa		Zbiornik paliwa		Zawór bezpieczeństwa



FordRanger



E145036

06/2006 – 07/2011

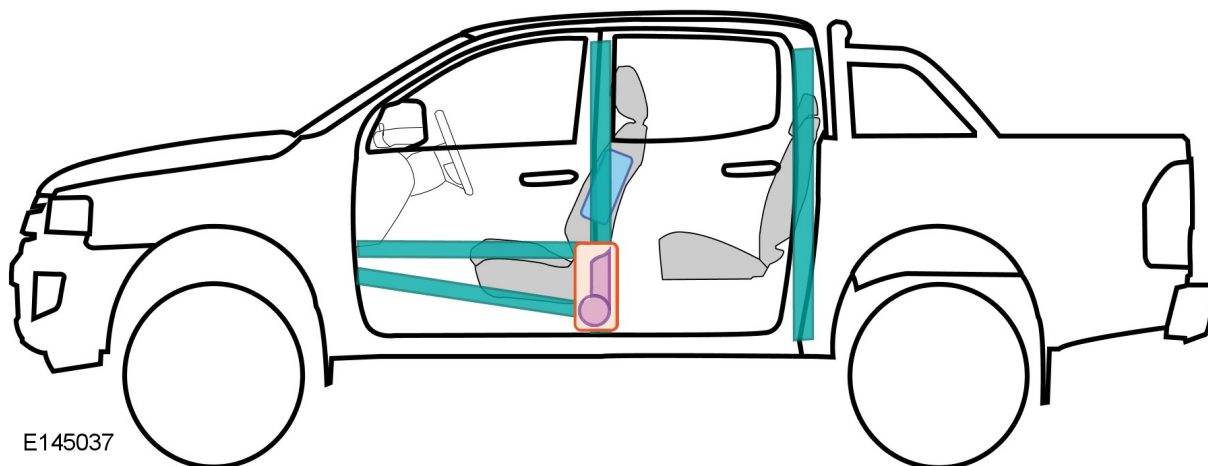
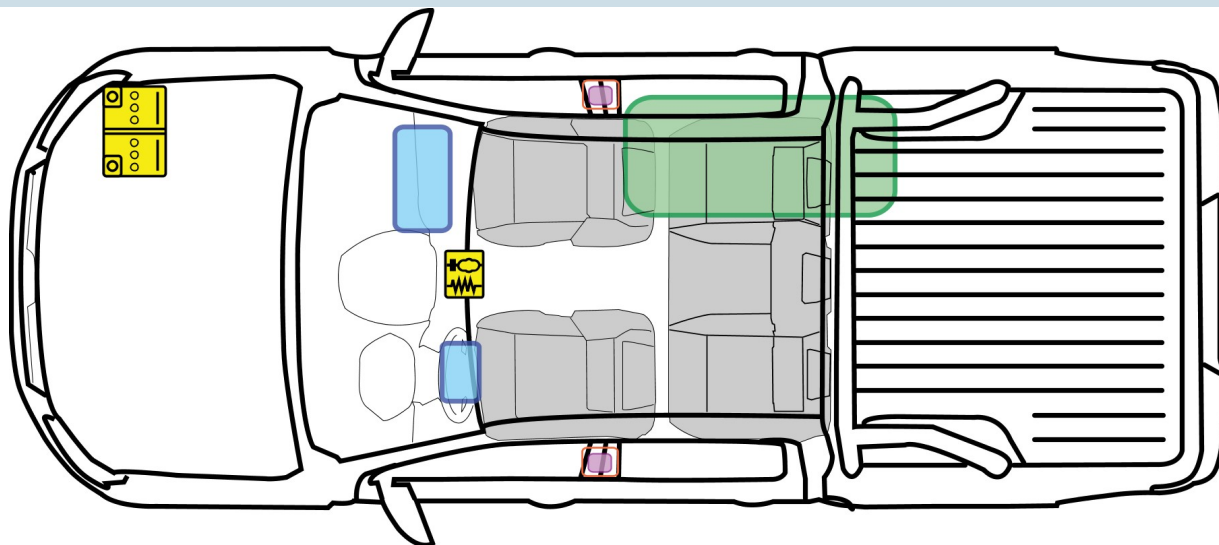

E145037

Legenda

R

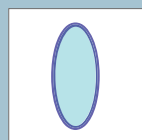

Ochronna poduszka powietrzna

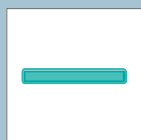

Wzmocnienia konstrukcji



Sterownik

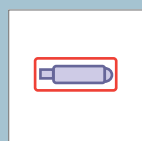

Generator gazu

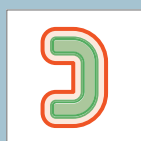

Aktywna ochrona w przypadku wywrócenia pojazdu
Sprężyna gazowa

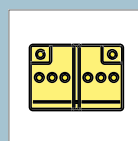

Akumulator

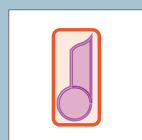

Napinacze pasów

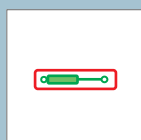

Zbiornik paliwa

FordRanger



07/2011 – >

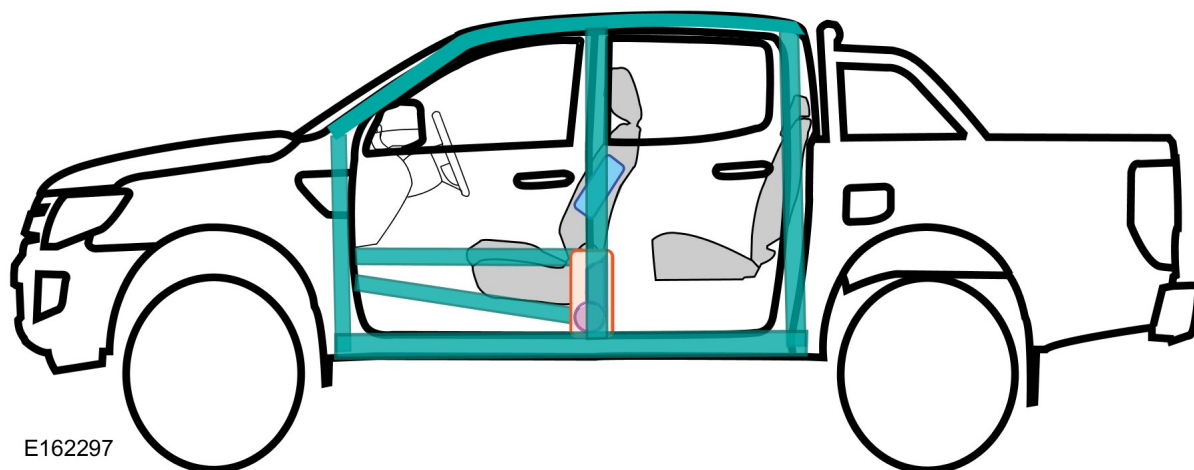
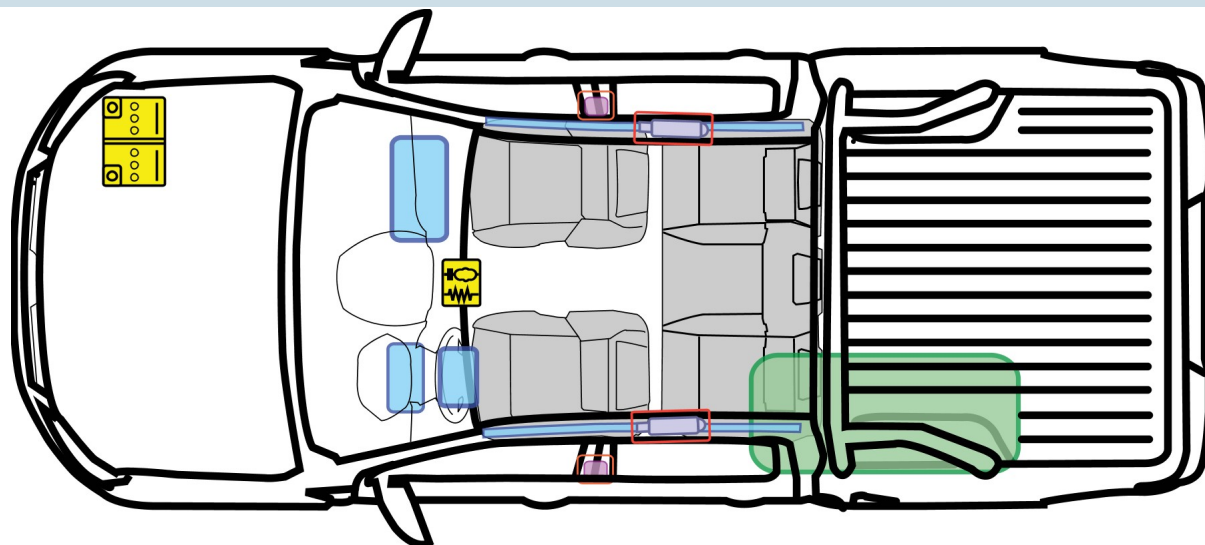

E162297

Legenda

R

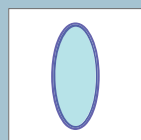

Ochronna poduszka powietrzna

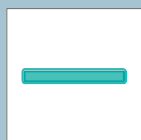

Wzmocnienia konstrukcji



Sterownik

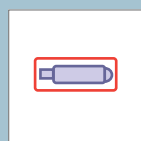

Generator gazu

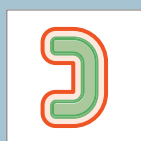

Aktywna ochrona w przypadku wywrócenia pojazdu
Sprężyna gazowa

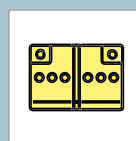

Akumulator

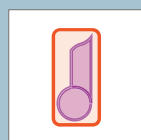

Napinaczy pasów



Zbiornik paliwa

Ford S-MAX



E138972



02/2006 – >

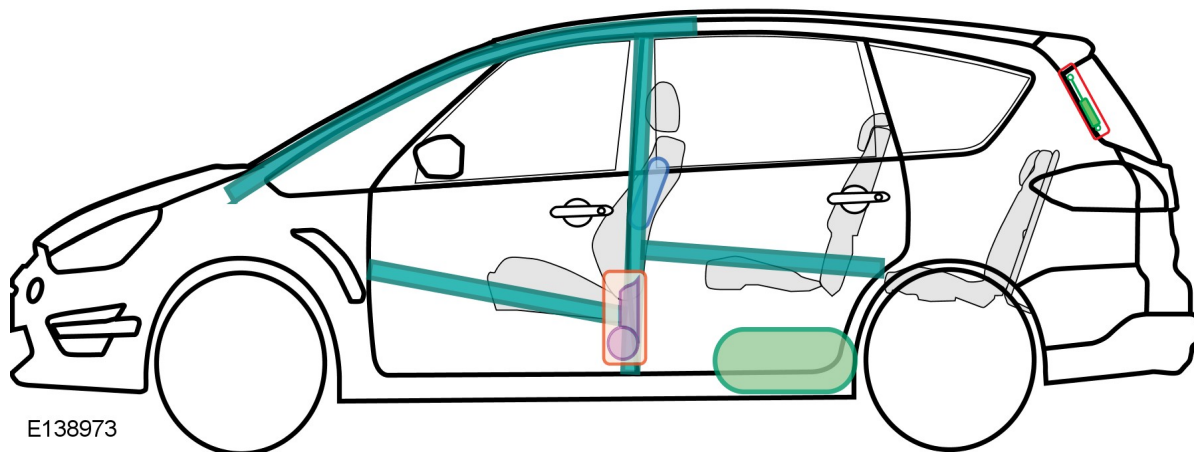
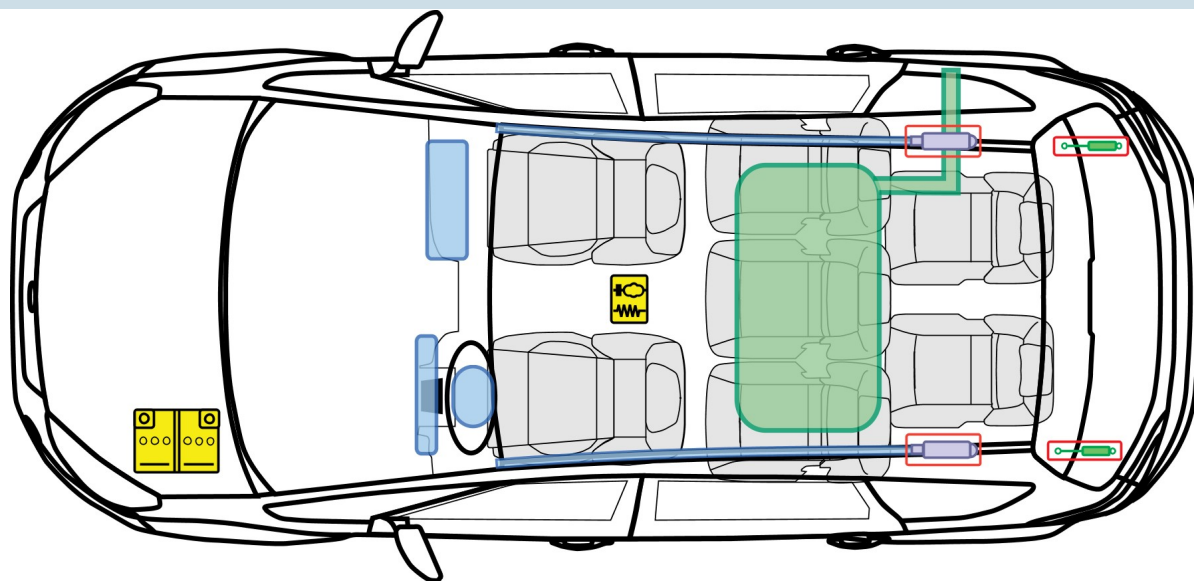

E138973

Legenda

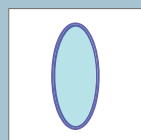

Ochronna poduszka powietrzna

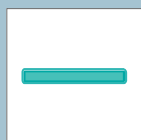

Wzmocnienia konstrukcji



Sterownik

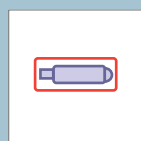

Generator gazu

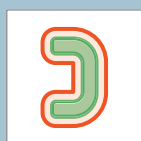

Aktywna ochrona w przypadku wywrócenia pojazdu
Sprężyna gazowa

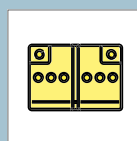

Akumulator

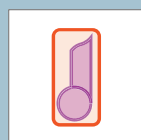

Napinaczy pasów



Zbiornik paliwa

S





E139141



01/2003 – 07/2005

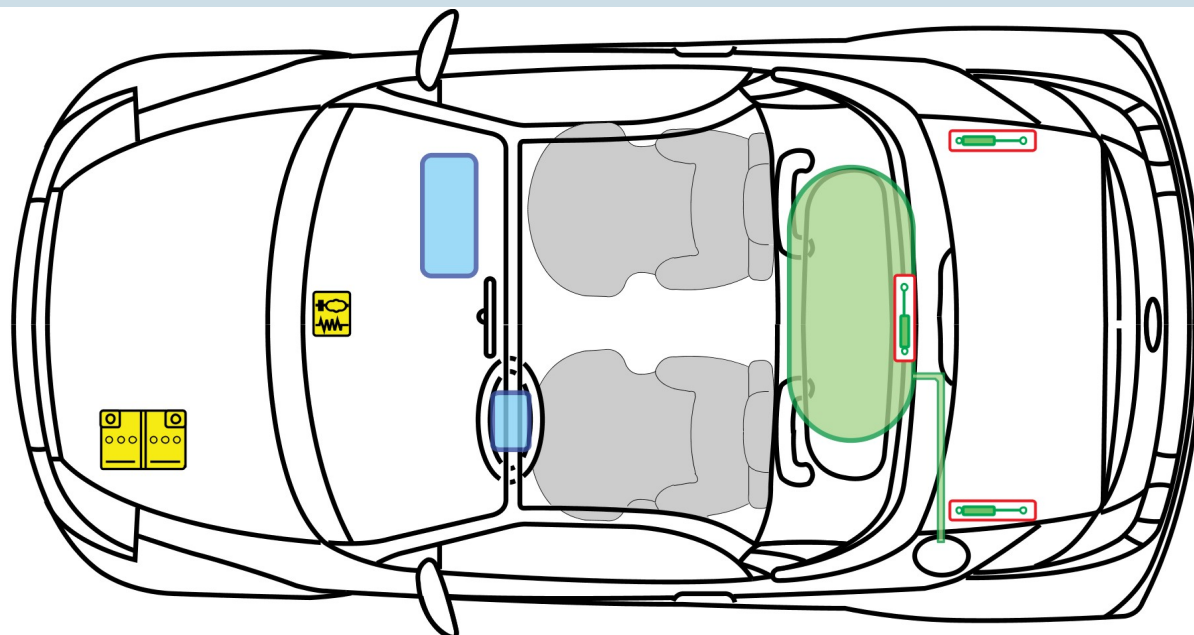

E139142

Legenda

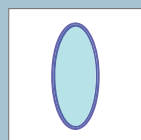

Ochronna poduszka powietrzna

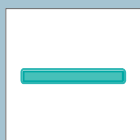

Wzmocnienia konstrukcji



Sterownik

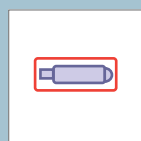

Generator gazu



Aktywna ochrona w przypadku wywrócenia pojazdu
Sprężyna gazowa

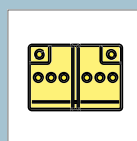

Akumulator

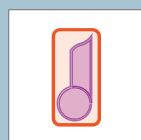

Napinacze pasów

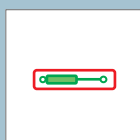

Zbiornik paliwa

Ford Tourneo Connect



E172424

09/2013 – >

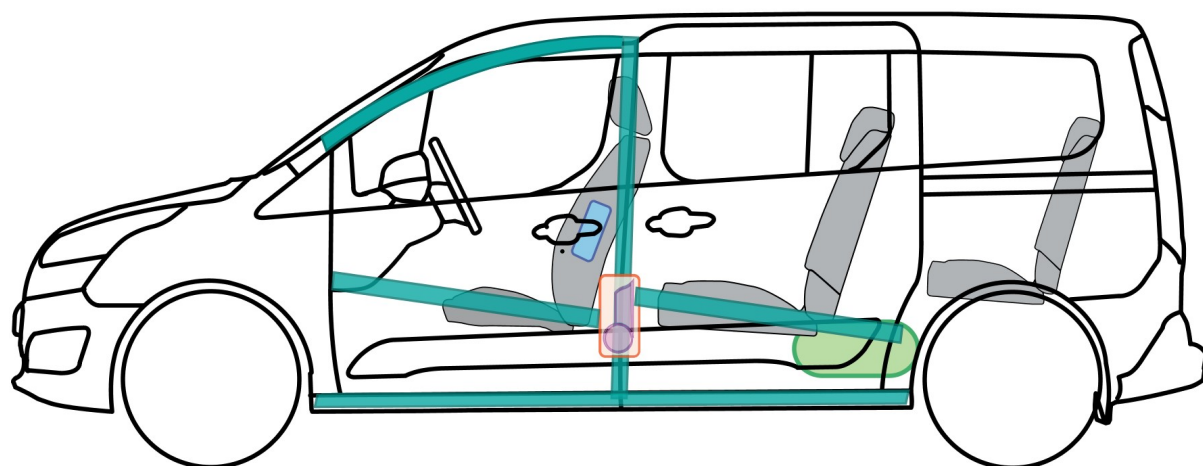
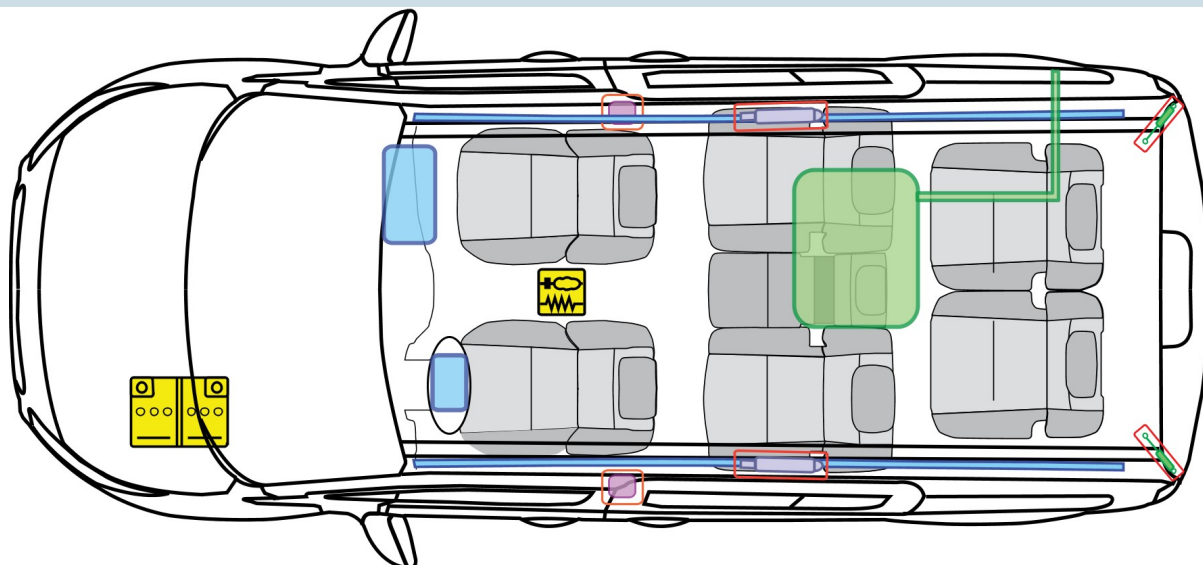

E172425

Legenda

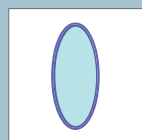

Ochronna poduszka powietrzna

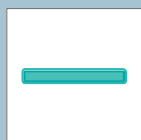

Wzmocnienia konstrukcji



Sterownik

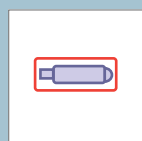

Generator gazu

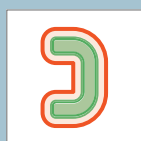

Aktywna ochrona w przypadku wywrócenia pojazdu
Sprężyna gazowa

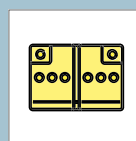

Akumulator

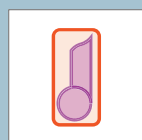

Napinaczy pasów

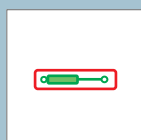

Zbiornik paliwa



Ford Tourneo Connect



E173306



06/2002 – 07/2013

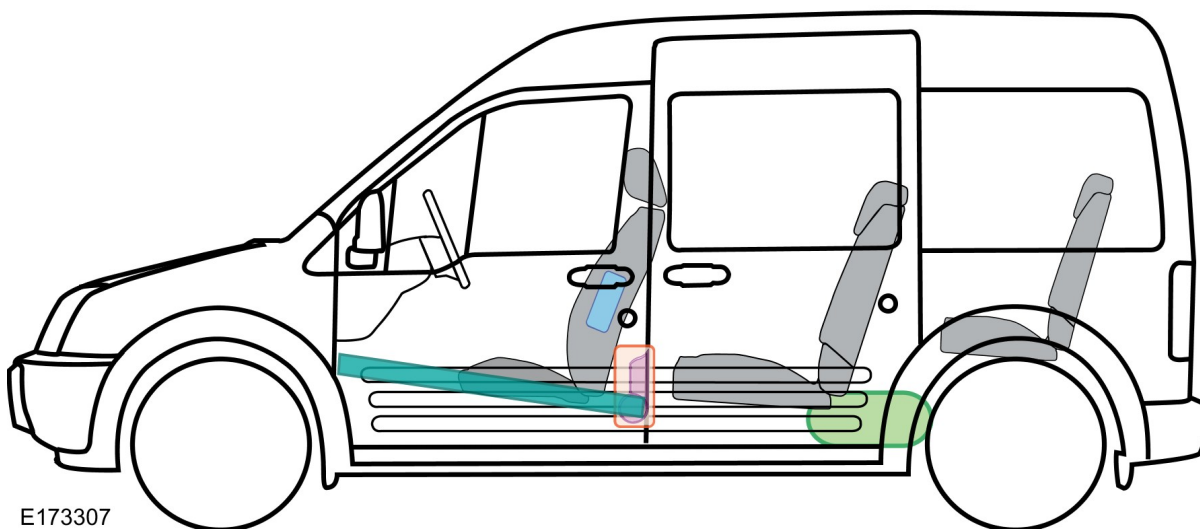
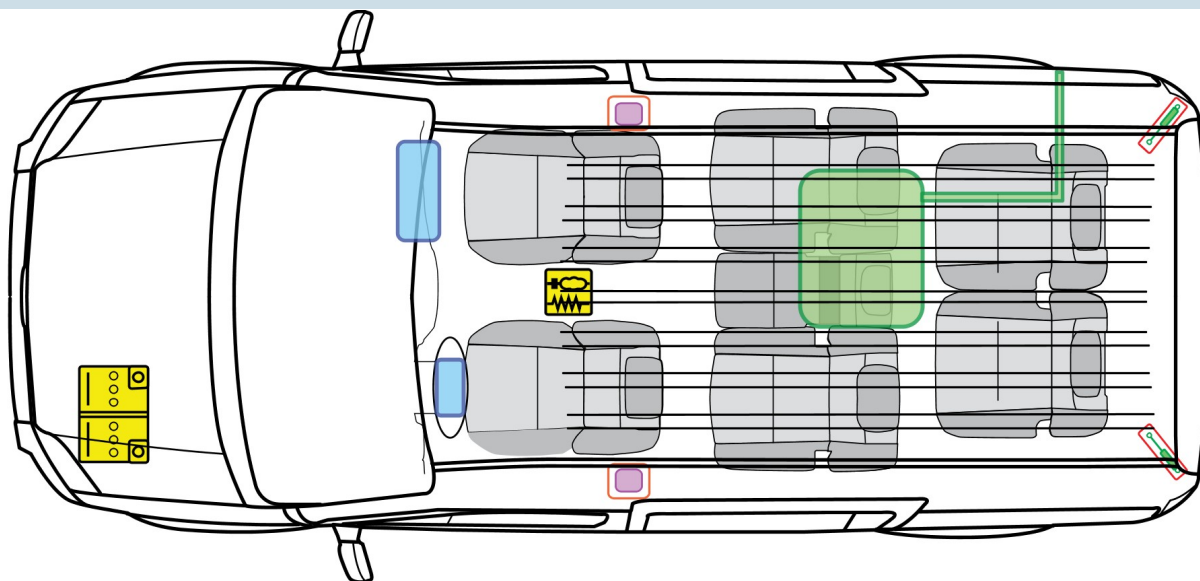

E173307

Legenda

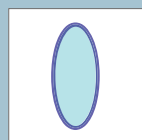

Ochronna poduszka powietrzna

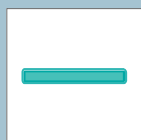

Wzmocnienia konstrukcji



Sterownik

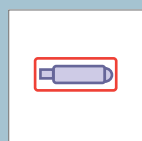

Generator gazu

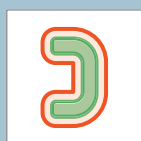

Aktywna ochrona w przypadku wywrócenia pojazdu
Sprężyna gazowa

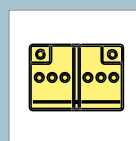

Akumulator

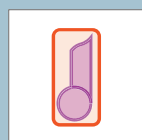

Napinacze pasów



Zbiornik paliwa

Ford Tourneo Courier



E179106



03/2014 – >

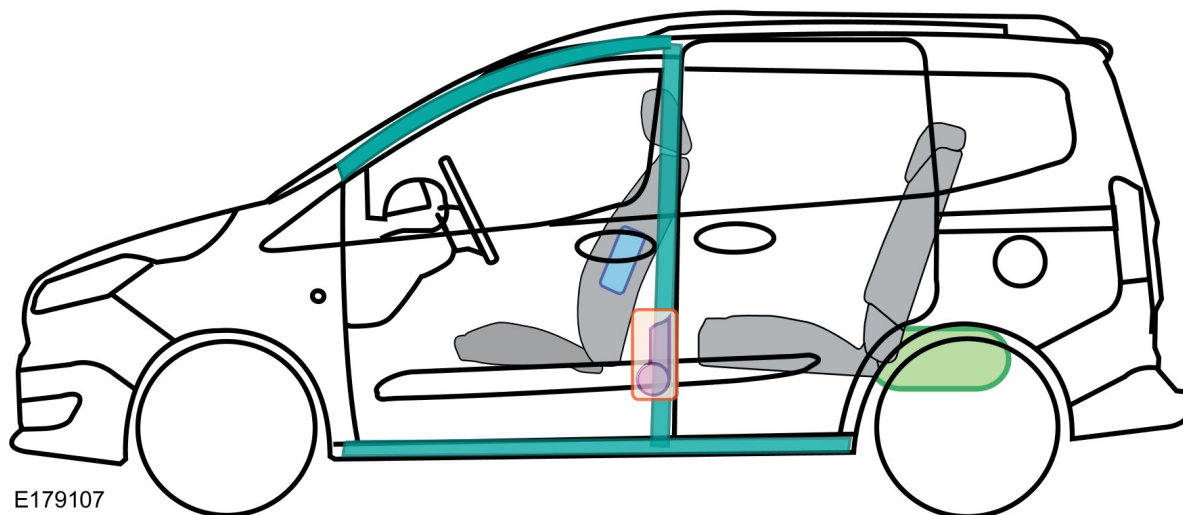
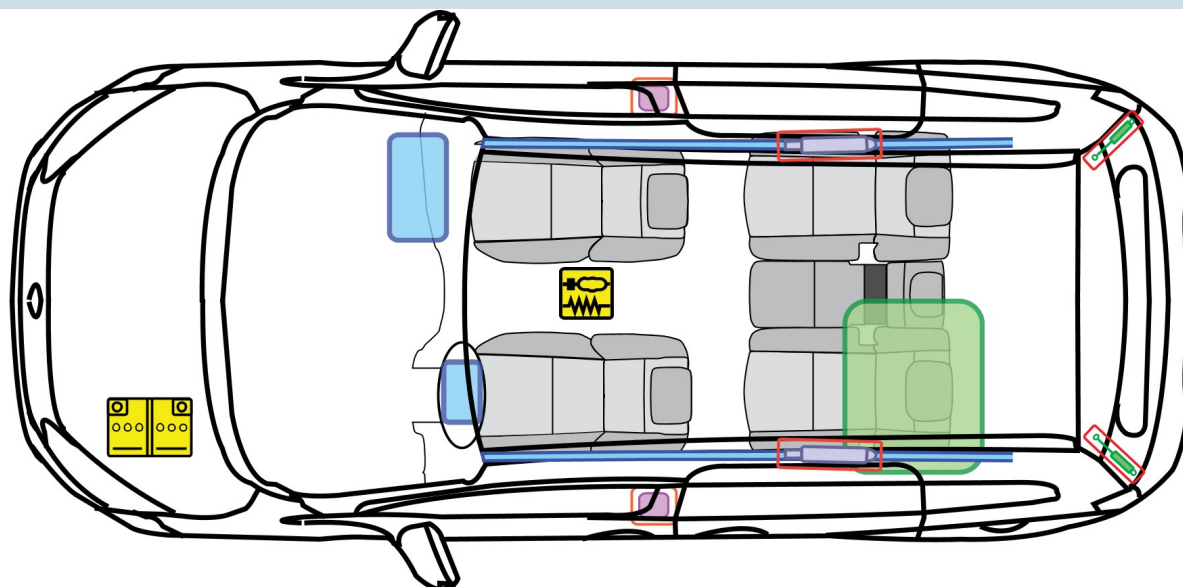

E179107

Legenda

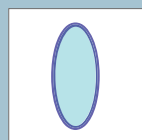

Ochronna poduszka powietrzna

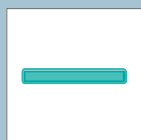

Wzmocnienia konstrukcji



Sterownik

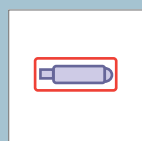

Generator gazu

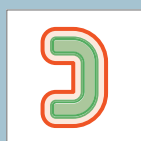

Aktywna ochrona w przypadku wywrócenia pojazdu
Sprężyna gazowa

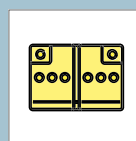

Akumulator

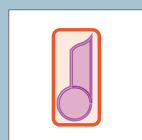

Napinaczy pasów

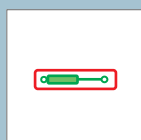

Zbiornik paliwa



Ford Tourneo Custom



E162349

07/2012 – >

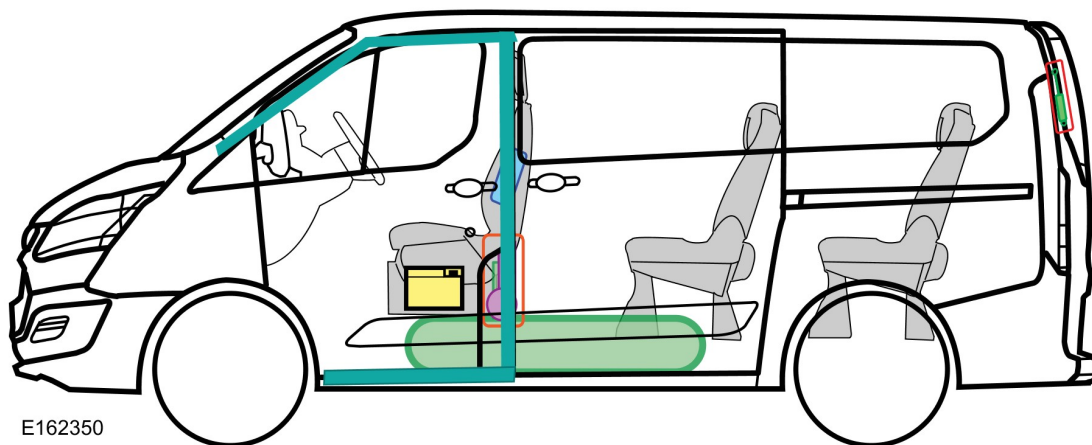
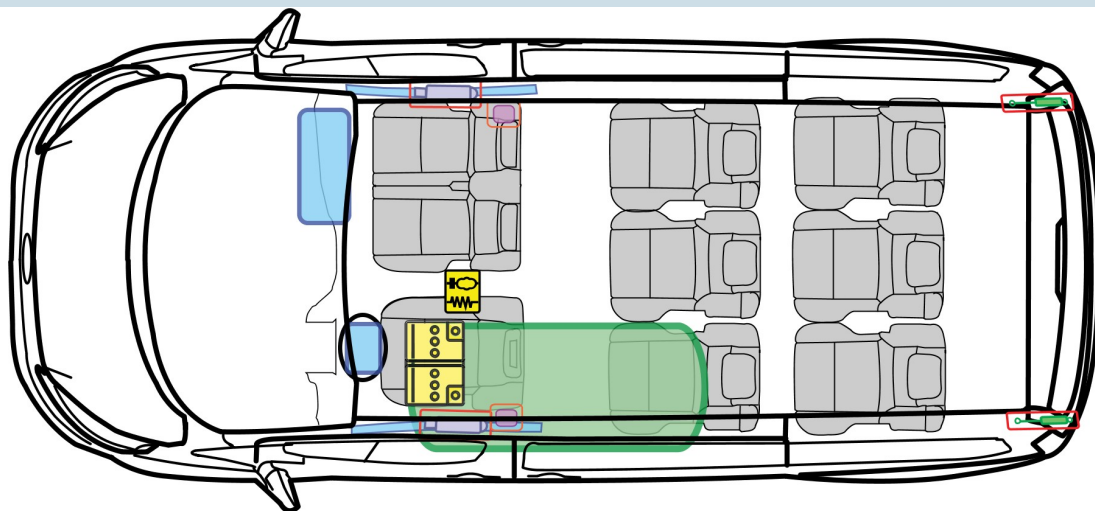

E162350

Legenda

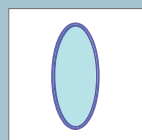

Ochronna poduszka powietrzna

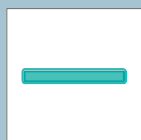

Wzmocnienia konstrukcji



Sterownik

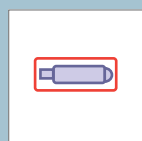

Generator gazu

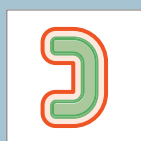

Aktywna ochrona w przypadku wywrócenia pojazdu
Sprężyna gazowa

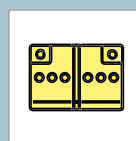

Akumulator

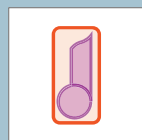

Napinacze pasów

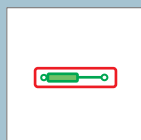

Zbiornik paliwa

Ford Transit Tourneo



E139150



08/2007 – >

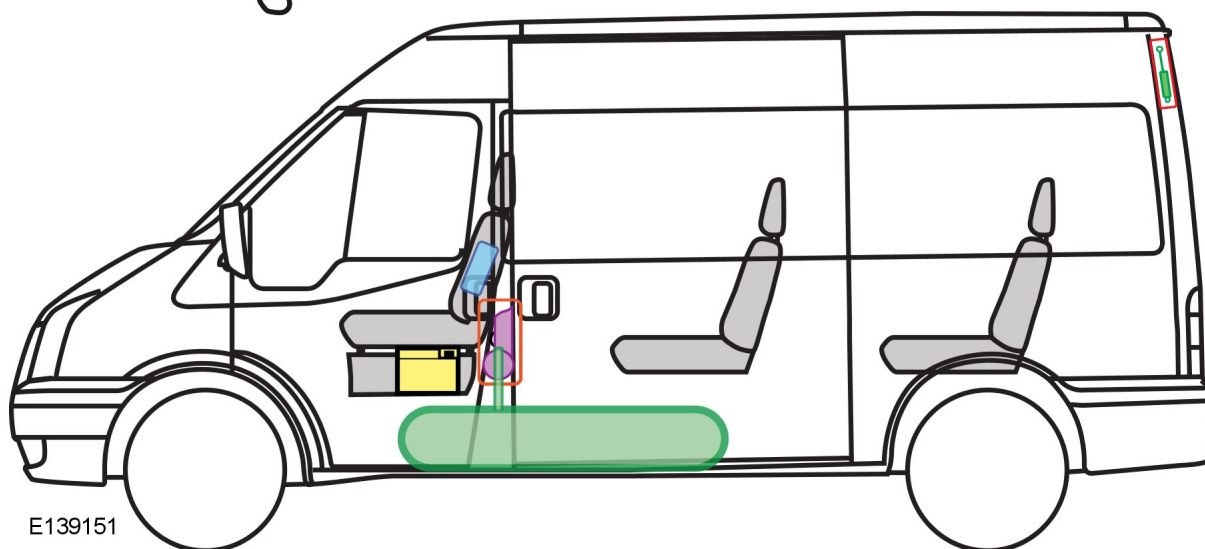
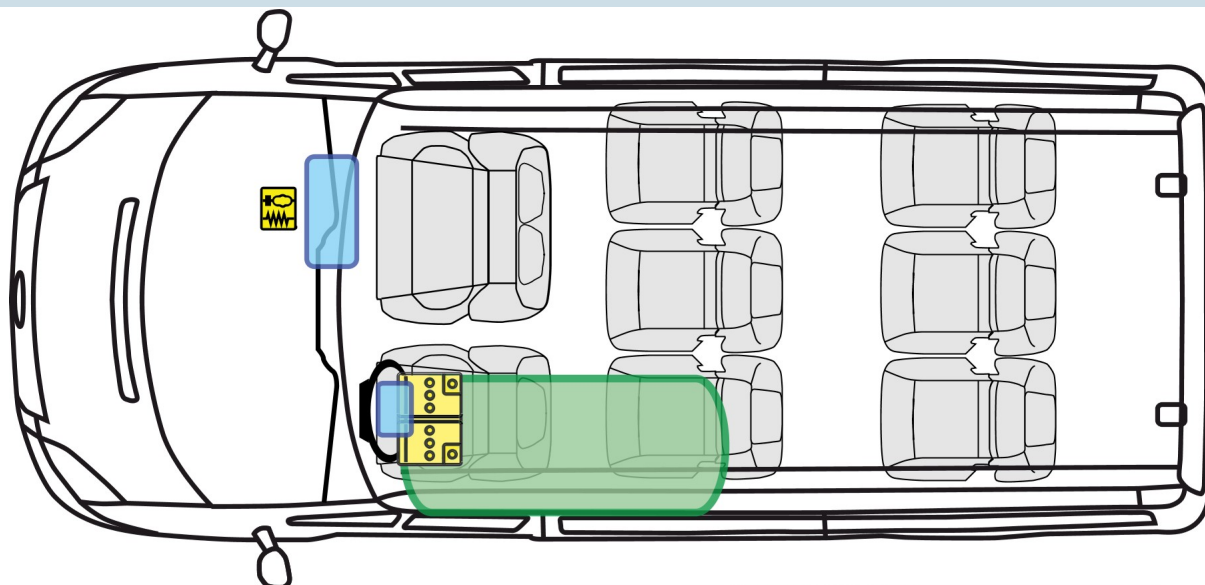

E139151

Legenda

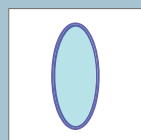

Ochronna poduszka powietrzna

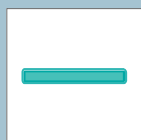

Wzmocnienia konstrukcji



Sterownik

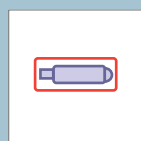

Generator gazu

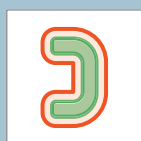

Aktywna ochrona w przypadku wywrócenia pojazdu
Sprężyna gazowa

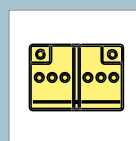

Akumulator

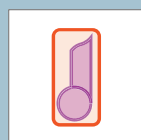

Napinacze pasów



Zbiornik paliwa